

## Planning Counter

---

**Subject:** Creating a walkable community in the Welby area  
**Attachments:** Walkable Community.pdf; walkability\_checklist.pdf; Lincoln Park Outside Gym.pdf

---

**From:** bobbullethalf . [<mailto:rmeeksjr@gmail.com>]  
**Sent:** Saturday, March 01, 2014 4:41 PM  
**To:** Joelle Greenland  
**Subject:** Creating a walkable community in the Welby area

Case Name: Welby Subarea Plan

Case Number: PLN2014-00004

Dear Adams County Planning:

Walkable commercial districts are a key component of communities that promote active living. Walking has great health benefits, including helping people maintain a healthy weight. Here are some factors to consider. There is great enthusiasm for walkable shopping areas among retail experts, developers and many residents of urban and suburban areas;

- Walking shopping areas have a potential to prosper as a result of demographics, increased gas prices, public policies encouraging higher densities and changing life style preferences;
- Businesses can be successful if such areas reach a critical mass, cater to diverse needs, are located in higher density areas or have good mass transit service, and have a supermarket as an anchor;
- With success, enterprises in walkable shopping areas are able to pay higher rents for their space, and housing near walkable commercial areas commonly sells for higher prices than in more distant areas.

Many communities have embraced pedestrian mobility as an alternative to older building practices that favor automobiles. Reasons for this shift include a belief that dependency on automobiles is ecologically unsustainable; automobile-oriented environments engender dangerous conditions to both motorists and pedestrians, and are generally bereft of aesthetics. Auto-focused designs also diminish walking and needed "eyes on the street provided by the steady presence of people in an area. Reduced walking also reduces social interaction, mixing of populations and pride in streets and other civic space.

There are several ways to make a community more walkable. Sidewalks should be implemented where there are "sidewalk gaps", with priority to areas where walking should be encouraged, such as around schools or transit stations. In Atlanta, safe routes to transit is a growing campaign to provide safer access to transit stops for pedestrians. When implementing new sidewalks, there are several aspects to consider. For example, the width of the sidewalk is important for walkability. The Americans with Disabilities Act (ADA) requires that sidewalks be at least five feet in width.

Obstructions like sign posts and utility poles can decrease the walkable width of the sidewalk, so alternative locations for these obstructions, especially sign posts, should be used. Quality maintenance and proper lighting of sidewalks should be sustained to reduce obstructions, improve safety, and overall encourage walking. Another way to make sidewalks safer is to implement buffers, which are areas of grass between the street and the sidewalk. An additional benefit of buffers is that the vegetation absorbs the carbon dioxide from automobile emissions and assists with water drainage.

Making crosswalks safer is also key to walkability. Curb extensions decrease the radii of the corners of the curb at intersections. Curb extensions calm traffic and decrease the distance pedestrians have to cross. On streets with parking, curb extensions allow pedestrians to see oncoming traffic better where they otherwise would be forced to walk into the street to see past parked cars. Striped crosswalks, or zebra crossing, also provide safer crossings because they provide better visibility for both drivers and pedestrians.

A further justification for walkability as a consideration in [urban](#) design and planning, is founded upon evolutionary and philosophical grounds, contending that gait has been vital to the [cerebral](#) development in humans. After millennia of human development firmly based upon gait, the twentieth century automotive and automated metropolis has separated walking from thinking, and in this sense it has become an agent of regression rather than human progress. Walkability, therefore, is offered as a critical component in contemporary urban design considerations, with implications far beyond the scope of current concerns.

Having done extensive traveling throughout the country my family and me have spent time at various vacation rentals from Florida to California. I have always wondered why we can't have something similar in our own state. I have attached some ideas for the committee to look over. There is one article that talks about Lincoln Park in San Francisco which had an outside gym, it was just phenomenal to see all the neighborhood people in such vicinity to a place. I hope that you take some of my considerations into account when developing the area, let's push through to a more modern community design.

Thanks for your time,

Robert Meeks, Jr.

# Creating Walkable Communities

*A guide for local governments*



## TABLE OF CONTENTS

Simply click on the topic you would like to read.

### Introduction

- What is the purpose of this report?
- What is a "Walkable Community"?
- What are the benefits of walkable communities?
- What are the challenges to making communities more walkable?

### Principles of Pedestrian Planning and Design

- About pedestrians and walking
- Elements of good pedestrian planning
- Good road design

### Guidelines for the Design of Pedestrian Facilities

- Design principles
- The where and when of sidewalks and walkways
- Designing sidewalks and walkways
- Corners
- Intersections and Crossings
- Sidewalk management and maintenance

### Other Design Topics

- Traffic Calming
- Transit
- School-related issues
- Trails and Greenways

### Planning for Walkable Communities

- Comprehensive plans
- Zoning provisions
- Site plans and design review
- Retrofitting existing areas to serve pedestrians

PREPARED FOR:

# MARC

**Mid-America Regional Council**

600 Broadway  
Suite 300  
Kansas City, Missouri 64105

816.474.4240  
[www.marc.org](http://www.marc.org)

PRODUCED BY:

**Bicycle Federation  
of America  
Campaign to Make  
America Walkable**

1506 21st Street NW  
Washington, D.C. 20036

**DECEMBER 1998**

**1.1  
WHAT IS THE PURPOSE  
OF THIS REPORT?**

**T**his report is designed to serve as a tool for local governments and concerned citizens in the Kansas City region. It presents guidelines, suggestions, and techniques on how to make communities more walkable and pedestrian-friendly.

The 100-plus local governments that make up the Mid-America Regional Council represent a very diverse set of communities: from large to small, rural to urban, built-out to rapidly growing. Therefore, not all the guidelines described in this guide will apply to every community. On the other hand, the needs and opportunities-and the benefits-associated with walkable communities are similar regardless of the differences in community type.

Walking is our oldest and most basic form of transportation. Each of us does it every day as some part of every trip. At the same time, walking has generally received little or no attention in the planning, design, and development of our communities. This includes such things as land-use planning (do we consider the impacts of low-density development on trip length?); zoning (do we encourage mixed land-use and compact development?); subdivision and site-plan review (do we provide for good access for people on foot?); and street and highway design (do we make sure that there will be good, safe places for people of all ages to walk?). There are tremendous opportunities to improve conditions for walking and in so doing, to make our communities more livable. This guide is intended to help make our region a place of walkable communities. Section 1 provides background information and defines walkable communities. Section 2 covers what is involved in creating these communities and presents the elements of good pedestrian planning. The details of how to make walkable communities a reality are covered in sections 3, 4, and 5.

**1.2  
WHAT IS A  
“WALKABLE  
COMMUNITY”?**

**T**here are various ways to define what we mean by “walkable.” Each local community should consider a definition that is appropriate for itself: how would the residents of your area define walkable? The Campaign to Make America Walkable, a national project, has developed the following statement as a general description of what you might expect to find in a walkable community.

**SECTION I**

**What is the purpose of this report?**

**What is a “Walkable Community”?**

**What are the benefits of walkable communities?**

**What are the challenges to making communities more walkable?**

**RETURN TO  
TABLE OF CONTENTS**



---

What does a  
“Walkable  
Community”  
Look Like?

- ◆ People of all ages and abilities have easy access to their community “on foot”—an automobile is not needed for every trip.
- ◆ People walk more and the community and neighborhoods are safer, healthier, and friendlier places.
- ◆ Parents feel comfortable about their children being outside in their neighborhoods; they don’t worry about the threat of motor vehicles.
- ◆ Children spend more time outside with other children and are more active, physically fit, and healthy.
- ◆ Streets and highways are designed or reconstructed to provide safe and comfortable facilities for pedestrians, and are safe and easy to cross for people of all ages and abilities.
- ◆ Pedestrians are given priority in neighborhood, work, school, and shopping areas. Motor vehicle speeds are reduced (and, in some places, motor vehicles have been eliminated entirely) to ensure compatibility with pedestrian traffic.
- ◆ Motor vehicle operating speeds are carefully controlled to ensure compatibility with adjacent land uses and the routine presence of pedestrians.
- ◆ Drivers of motor vehicles operate them in a prudent, responsible fashion, knowing that they will be held strictly accountable for any threat, injury, or death caused by their lack of due care or violation of the vehicle code.
- ◆ The air and water quality is good.

Source: *Adapted from Campaign to Make America Walkable, A Vision of a Walkable Community (Washington, DC, 1997).*

---

**Figure 1.1**  
*An Example of  
Good Pedestrian  
Conditions*



---

To achieve such a vision, a community needs to address the following elements.

## CHARACTERISTICS OF A WALKABLE COMMUNITY:

◆ ***Coherence.***

A clear, understandable and organized sidewalk, street and land-use system consistent with the scale and function of the surrounding urban context. The sidewalk and street system should link points of interest and activity, provide clean lines of sight and travel, and include simple instructive signage.

◆ ***Continuity.***

A pattern of design and usage that unifies the pedestrian system.

◆ ***Equilibrium.***

A balance among transportation modes that will accommodate and encourage pedestrian participation.

◆ ***Safety.***

Pedestrian protection from automobiles and bicycles. Adequate time to cross intersections without interference. Physical separation from fast-moving cars. Signalization protection when crossing intersections.

◆ ***Comfort.***

Secure and negotiable paving materials for sidewalks and crosswalks. Unobstructed passage on the sidewalk and at corners. Signals timed to enable safe and quick crossings.

◆ ***Sociability.***

A sense of hospitality and suitability for individual and community interactions. Sidewalks should provide for a variety of uses and activities characteristics of the diverse urban scene.

◆ ***Accessibility.***

The opportunity for all individuals to utilize the pedestrian environment as fully as possible.

◆ ***Efficiency.***

Simplicity and cost-effectiveness in design and function. Minimum delay along a walking route.

◆ ***Attractiveness.***

Clean, efficient and well-maintained surroundings, with adjacent storefronts and activities that provide sidewalk interest.

Source: *Walk Boston, A Pedestrian Perspective on the Central Artery Project in Downtown Boston: A Report by the Pedestrian Issues Task Force (Boston, MA, 1994).*



## 1.3 WHAT ARE THE BENEFITS OF WALKABLE COMMUNITIES?

The 1995 Oregon Bicycle and Pedestrian Plan<sup>1</sup> notes that increased walking will help reduce traffic congestion, air and noise pollution, wear and tear on roads, and consumption of petroleum; it will reduce the number of pedestrian-motor vehicle-related crashes, injuries, and fatalities; and it will reduce the need for additional roads, travel lanes and parking. The plan also notes that the number of people who are walking (or riding bicycles) is an important measure of the quality of life of a community.

---

### More Active and Healthier People

The U.S. Surgeon General issued a report recently that confirms what most of us already know: Americans aren't getting enough exercise.<sup>2</sup> The American Heart Association has listed physical inactivity as the fourth major risk factor associated with chronic disease. And, of great concern to public health officials in all parts of the United States, the trend is getting worse: almost half of all children don't get enough exercise and nearly one-fourth engage in no form of real physical activity.

The public health community is working to encourage Americans to become more active, and one of the major focuses of their efforts is promoting walking. It is inexpensive, it can be done by almost everyone, and-if conditions are right-it can be done almost everywhere. Unfortunately, in many communities today, "conditions" aren't very good for walking. In fact, most school-age children do not have a very good, safe route to walk to school. So public health workers and agencies are lending their support to efforts to create more walkable (and bicycle-friendly) communities.

---

### People- and Family- Oriented Community Development

A recent study, *Emerging Trends in Real Estate*, calls pedestrian-friendly traditional neighborhood developments (TNDs) the newest "market to watch." "Sample the attitudes of suburbanites today and you'll find a growing number who think their lifestyle is becoming more difficult and less appealing. [They are] exasperated by the amount of time spent trapped in their cars."<sup>3</sup> Roadway congestion and dependence on automobile travel detract from the livability of communities-particularly for seniors, parents and their children, and people with disabilities. Suburban development has become less inviting to investors, who now must evaluate the consequences of low-density development.

<sup>1</sup> Oregon Department of Transportation, *Oregon Plan for Bicycles and Pedestrians* (Salem, OR, 1995).

<sup>2</sup> U.S. Department of Health and Human Services, *Physical Activity and Health: A Report of the Surgeon General* (Washington, DC, 1996).

<sup>3</sup> Real Estate Research Corporation, *Emerging Trends in Real Estate 1998* (Chicago, IL, 1998).



New home buyers are looking for neighborhoods that are family-friendly, with sidewalks and calm traffic, green space and trails. Good schools have long been an important factor for parents in deciding where to buy a home—now many are also concerned about having good ways for their children to get to school. A growing number of retirees are also looking for more walkable places and spaces in which to live, and more options for travel.

---

## Transportation Choices

A vast majority of people believe that transportation is about more than roads, and that public transportation funds should be spent on improvements that benefit people and families.<sup>4</sup> Not surprisingly, suburban parents, particularly mothers (“soccer moms”), are the most supportive of these kinds of improvements. But others, too, are discovering the benefits to having a range of transportation options from which to choose. The goal should be to give people a range of transportation choices and encourage them to select the mode that makes the most sense for any given trip. According to a Portland, Oregon study,<sup>5</sup> people who live in pedestrian-friendly neighborhoods 1) make four times as many walking and biking trips; 2) make three times as many transit trips; 3) take fewer car trips; and 4) drive fewer miles.

---

## Independent Mobility for Children

Many parents and others are looking for opportunities that allow children to lead more active and independent lives, but the current transportation infrastructure has left a series of barriers and obstacles that can make independent mobility for children a challenge to achieve. Parents want their children to be safe-in and around their neighborhoods, schools and recreation areas. But most suburban neighborhoods built over the past 50 years are today overrun with fast motor vehicle traffic, and generally lack sidewalks. Now, new attention is being given to slowing motor vehicles down in neighborhoods through techniques called “traffic calming,” and programs such as “Walk a Child to School” (sponsored by the Partnership for a Walkable America) are encouraging parents and school officials to work together to make neighborhoods places that are safe for children to get around in on their own.

---

## Accessibility for All

Age and functional disability can reduce a person’s mobility. Fortunately, good pedestrian facility design can help ensure that virtually everyone can continue to enjoy some level of mobility. As the Baby Boom generation approaches retirement age, communities across America will need to rethink how they provide transportation services and choices. Older Americans need more transportation options, not less-driving should not be the only option. Transit and paratransit services and more walkable environments help to maintain personal mobility and access through the senior years.

<sup>4</sup> Random-sample survey of 707 likely voters, conducted by Lake Research for the Bikes Belong! Campaign (Washington, DC, January 1997). Sixty-four percent of respondents supported using one percent of gasoline taxes for such things as sidewalks, bicycle lanes and multiple-use trails.

<sup>5</sup> Parsons Brinckerhoff Quade and Douglas, with Cambridge Systematics and Calthorpe Associates, “The Pedestrian Environment,” in Making the Land Use Transportation Air Quality Connection, Vol. 4A (Portland, OR, 1993).





The Americans with Disabilities Act (ADA), signed into law in 1990, seeks to assure that all Americans—including those with disabilities—will have full access to public facilities and services. Good accommodations for pedestrians, including disabled pedestrians—people using wheelchairs and other mobility aids, people with low vision and the blind—is critical to meeting the requirements of ADA.

---

## Lower Income Mobility

People in low-income households are nearly twice as likely to walk as people in other income groups.<sup>6</sup> About a quarter of low-income households do not have a car (compared to four percent of other households) and individuals in these households must rely on walking and transit for many of their trips. For these travelers, safe and convenient walking routes, including routes to transit hubs and stops, are a critical element of the transportation system.

### 1.4 WHAT ARE THE CHALLENGES TO MAKING COMMUNITIES MORE WALKABLE?

If more walkable communities are such a good thing, what's keeping us from having more of them? Perhaps the best explanation is that pedestrians and walking have been left out of the processes of land-use planning and of the planning, design, and operation of streets and highways.

---

## Lower Density Development

Over the past 30 years, the population in metropolitan Kansas City has increased by 113 percent. During this same time period, the urbanized land area expanded by 489 percent. The region is often characterized as the metropolitan area with the most highway miles per capita in the United States. Our region has few physical constraints to continued outward development. As a result, the low-density suburban development patterns and transportation investments have created environments that don't support and encourage walking.

The Kansas City region, like much of the nation, has become heavily dependent on the automobile. The separation of land uses, the low-density nature of development, and roadway design oriented to meeting the needs of motorists have all contributed to our heavy dependence on motor vehicles.

Compact, mixed-use development (e.g., locating employment and shopping closer to residential areas) allows nonmotorized transportation—walking and bicycling—and transit to work more effectively. This type of higher-density development serves to both accommodate and encourage use of these modes as alternatives to the automobile. Although this will not solve the congestion problem, it is a start, and reduces public infra-

<sup>6</sup> Mirukami, E. and J. Young, *Daily Travel by Persons with Low Incomes*. Presented at the Nationwide Personal Transportation Survey Symposium (Bethesda, MD, 1997).



---

## Transportation Facility Barriers

structure requirements and costs. Not only does low-density development create barriers to walking, it is bad for local economies as well. The good news is that there is growing support for better design of new communities and there are ways to go back and fix the problems in existing neighborhoods.

Some aspects of how we have developed our transportation facilities act as major deterrents to walking and create obstacles to travel for pedestrians and disabled people. These include:

- ◆ Lack of sidewalks
- ◆ Narrow walkway widths
- ◆ Missing curb cuts
- ◆ Poorly constructed and/or maintained walking surfaces
- ◆ Difficult street crossings (e.g., too wide, too fast)
- ◆ Inadequate bridge design (e.g., no place to walk)
- ◆ Physical features (e.g., rivers, railroad tracks, major arterial streets lacking pedestrian crossings)
- ◆ Inadequate facilities for access to transit services
- ◆ High-speed, high volume traffic adjacent to schools, parks, shopping, and residential areas
- ◆ Inadequate sidewalk maintenance (including snow/ice removal and repair)

Source: *Campaign to Make America Walkable (Washington, DC, 1998).*

---

## Safety

Pedestrian safety is a major traffic safety problem, and one that has typically been overlooked or ignored. More than 5400 pedestrians were killed in traffic crashes in the United States in 1996, about 13 percent of the nation's total traffic-related fatalities.<sup>7</sup> Here are some additional details on this problem using the 1996 national data.

### **TRAFFIC-RELATED PEDESTRIAN FATALITIES IN 1996**

- ◆ Most pedestrian fatalities occurred in urban areas (71 percent).
- ◆ Nearly one-third (31 percent) of all children between the ages of 5 and 9 years who were killed in traffic crashes were pedestrians.
- ◆ More than one-fifth (22 percent) of all traffic fatalities under age 16 were pedestrians.
- \* ◆ Almost half (43 percent) of the 715 pedestrian fatalities under 16 years of age were killed in crashes that occurred between 4:00 p.m. and 8:00 p.m.

<sup>7</sup> National Highway Traffic Safety Administration, *Pedestrian Safety Facts* (Washington, DC, 1998).



- ◆ Older pedestrians (ages 70+) accounted for 18 percent of all pedestrian fatalities. The death rate for this group was 3.92 per 100,000 population- higher than for any other age group.

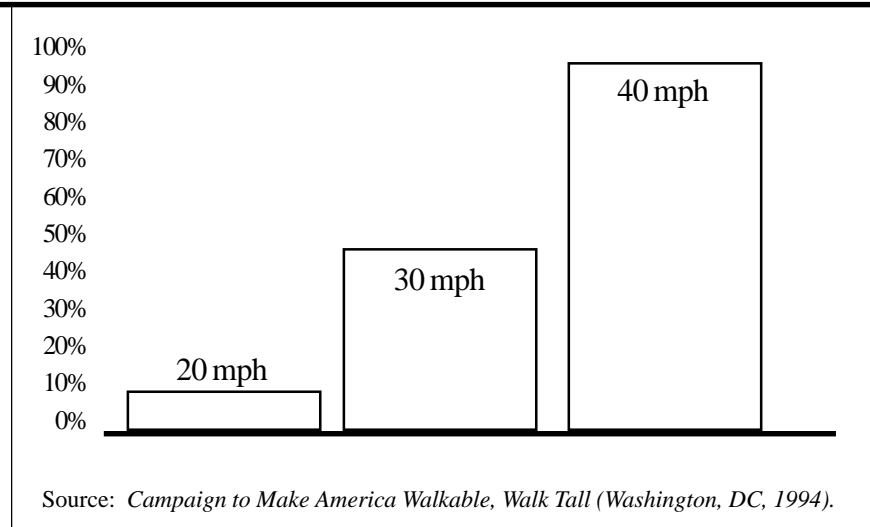
Source: *National Highway Traffic Safety Administration, Pedestrian Safety Facts* (Washington, DC, 1998).

Most pedestrians are killed by cars on neighborhood streets-the streets where people live and walk, and where children play. This problem is evident in many communities where neighborhood streets are becoming speedways due to so-called “design improvements” which make them wider, or when they are invaded by commuters rushing to work, delivery drivers, or unsafe drivers just looking for a shortcut. Add to this a nearly complete lack of effective speed enforcement and it comes at no surprise that neighborhoods are being overrun by cars and that fewer people are walking today.

Part of the problem is that pedestrian safety has usually been a secondary traffic engineering issue. The overriding goal of traffic engineering has been to improve roadway “level of service” which often means designing roads with wide lanes and shoulders, large turn radii at intersections, passing and turning lanes, and other features that enable more motor vehicles to travel at higher speeds. Few efforts have focused on ensuring that streets are safe for both pedestrians and motor vehicles and fewer still have sought to modify driving behavior to better protect and accommodate pedestrian travel.

Increased speeds put pedestrians at higher risk. A ten-mile-per-hour increase in speed, from 20 mph to 30 mph, increases the risk of death for a pedestrian in a collision ninefold. If a car going 20 miles per hour hits a pedestrian, there is a 95 percent chance that the person will survive. However, if the same car is traveling 30 mph, the pedestrian’s chances of survival are reduced to 45 percent (see fig. 1.2).<sup>8</sup>

**Figure 1.2**  
*Fatalities based on speed of vehicle*



<sup>8</sup> Pedestrian Federation of America, *Walk Tall: A Citizen’s Guide to Walkable Communities*, (Washington, DC, 1994).



## 1.5 SUMMARY

Creating walkable communities is a challenge: much of what we've done over the past 50 years-in terms of how we've developed our communities and our transportation facilities-has made it harder to walk and to get to places we might want to go. Still, many people do walk, and there are signs that they'd like to do more of it. This is good news because we need to make walking a more regular, routine part of our lives-and of our children's lives-again.

We need to give people more choices on how to travel when it comes time to make a trip to the store, to go to school, to go to the park or library, or to visit a friend. We need to make neighborhoods places where parents feel comfortable with their children running around, playing with friends. We need to make our communities places where the elderly and the disabled are free to move around in relative comfort and safety. We need to make the places where we live and the places where we work environments that encourage us to be active-to walk to the store, to walk to lunch, or perhaps to take an evening stroll just for the health of it!

That's why we need to make our communities more walkable. The rest of this guide looks at what can be done-in old neighborhoods and new-to create walkable communities. It describes the qualities and characteristics of walkable communities so we will know what we need to do. And it details how to build things right, like sidewalks and intersections. And it focuses on some special techniques such as traffic calming that can help us reduce the threat from motor vehicles.

The ideas and suggestions contained in this guide come from communities around the country, some of them in this region. In fact, it is possible to find examples of virtually everything presented in this guide somewhere in the Mid-America region. Many good examples of walkable neighborhoods can be found in older parts of our cities and towns. Perhaps the most important ingredients for the success of this endeavor are the belief that it can be done and the commitment to make it happen.



**SECTION 2**

**About pedestrians and walking**

**Elements of good pedestrian planning**

**Good road design**

**RETURN TO TABLE OF CONTENTS**

This section of the guide covers what is involved in creating walkable communities. It begins with a look at some of the characteristics of pedestrians, walking trips, and safety issues. It then presents the elements of good pedestrian planning: what it takes to make a walkable community. Finally, it concludes with a discussion of good road design from the perspective of the pedestrian.

**2.1 ABOUT PEDESTRIANS AND WALKING**

Walking is the number-one method of human transport in the world. Virtually everyone does it and it makes up some part of nearly every trip. While this may seem obvious, it has none the less been routinely overlooked in the planning and development of our communities and in the design of our transportation facilities.

- Age 0 to 4 ..... ◆ Learning to walk
  - ◆ Requiring parental supervision
  - ◆ Developing peripheral vision, depth perception
- Age 5 to 12 ..... ◆ Increasing independence
  - ◆ Poor depth perception
  - ◆ Susceptible to “dart out”/intersection dash behaviors
- Age 13 to 18 ..... ◆ Sense of invulnerability
  - ◆ Intersection dash
- Age 19 to 40 ..... ◆ Active, fully aware of traffic environment
- Age 41 to 65 ..... ◆ Slowing of reflexes
- Age 65+ ..... ◆ Street crossing difficulty
  - ◆ Poor vision
  - ◆ Difficulty hearing vehicles approaching from behind
  - ◆ Higher fatality rate

Source: City of Bellevue, *Youth Link Survey* (Bellevue, WA, 1991).

*Common Pedestrian Characteristics*

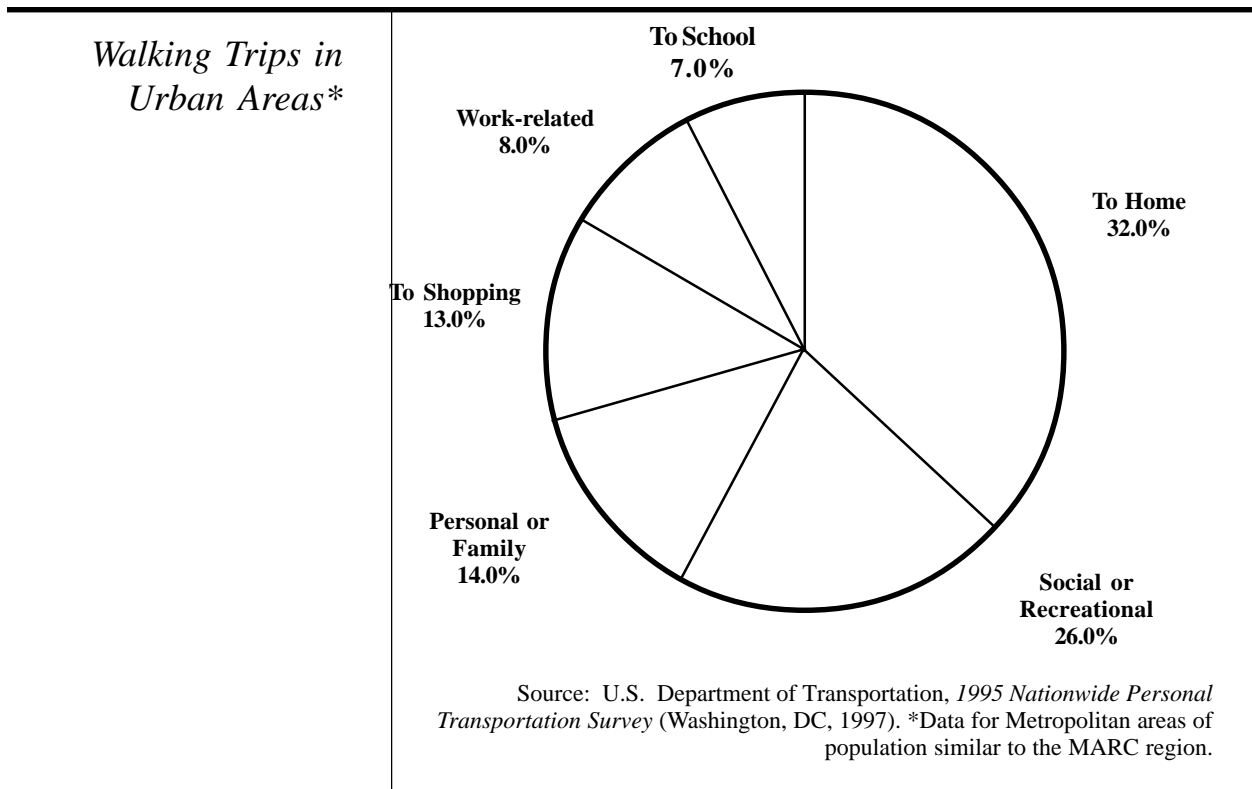


Children and elderly are most likely to depend on walking for many trip purposes. In many cases if adequate provisions for walking are not available, these individuals will become transportation-dependent; that is, they will be forced to rely on someone else to accommodate their travel needs.

For years, most transportation and land-use planning in this country has tended to overlook the needs of children. A major problem nationwide is that many children no longer are able to walk to local schools and parks. The distances are too great or no facilities are provided to accommodate walking. Further, many school boards are making decisions on where to locate new schools that limit options for walking by choosing sites far removed from the homes of the children expected to attend them. This trend has resulted in increasing costs in school busing and contributed to a serious decline in the level of physical activity and the general health of children. This trend does not reflect the wishes of the children; a survey of 6th through 12th grade public and private school students showed that about 75 percent were willing to consider walking or bicycling to school as an alternative mode.<sup>9</sup>

**WHY DO  
PEOPLE WALK?**

According to national surveys, walking trips are made for all kinds of purposes.



<sup>9</sup> City of Bellevue, *Youth Link Survey*.



**DISTANCE**

Distance is the key factor limiting utilitarian walking trips. Although distance is a subjective factor in mode choice, walking trips are predominantly short. When asked what they considered the maximum distance suitable for walking on errands, 40 percent of Seattle residents reported one mile or less and 70 percent reported two miles or less.

Residents of Ontario, Canada were asked how many minutes they would be willing to walk on errands and to work. The average for both trips was just over 20 minutes, which translates to about 1.25 miles. Pedestrians prefer to limit walking distances and will often take unusual short cuts to save a few steps or a few seconds of time. This is an important fact to keep in mind when considering the use of overpasses and underpasses. Pedestrians will generally not travel further than 600 feet to use a pedestrian overpass if an alternate, but less safe, at-grade crossing is available. Acceptable walking distances are dependent on trip purpose, total travel time related to this purpose, physical condition of the pedestrian, walking environment, perceived safety and security of the walking route, and in some instances, economic factors.<sup>10</sup>

The 1995 Nationwide Personal Transportation Survey established that at least 5.4 percent of all trips are made by walking. The study also revealed that the average pedestrian trip length was 0.53 miles. A more detailed description of walking trip purposes and average trip length (both in distance and time) is presented in figure 2.1.<sup>11</sup>

**Figure 2.1**  
*Average Trip Characteristics by Purpose*

PURPOSE OF TRIP	DISTANCE (miles)	DURATION (minutes)
To or from work .....	0.74 .....	10.86
Work-related business .....	0.5 .....	9.11
Shopping .....	0.44 .....	9.42
Other family or personal business .....	0.45 .....	9.06
School/church .....	0.55 .....	10.89
Doctor/dentist .....	0.81 .....	14.8
Vacation .....	1.41 .....	18.96
Visit friends or relatives .....	0.47 .....	9.07
Other social/recreational .....	0.64 .....	12.74
Other .....	0.79 .....	12.37

<sup>10</sup>Federal Highway Administration, *Handbook on Planning, Design, and Maintenance of Pedestrian Facilities* (Washington, DC, 1989).

<sup>11</sup>U.S. Department of Transportation, *1995 Nationwide Personal Transportation Survey* (Washington, DC, 1997).



## WALKING SPEED

Walking rates are generally 2.5 to 6.0 feet per second with an average of 4.0 feet per second, according to the Manual on Uniform Traffic Control Devices (MUTCD).<sup>12</sup> However, many studies acknowledge that the speed is significantly slower for older pedestrians and propose that a walking rate of 3.0 feet per second should be considered.<sup>13</sup> A new report issued by the Institute of Transportation Engineers (ITE) states “the fifteenth percentile walking speed should be used for setting the design walk speed where there is a high proportion of elderly pedestrians. In the absence of a specific study this would be between 3 and 4 feet per second, depending on the presence of slower pedestrians.”<sup>14</sup>

## CRASH TYPES AND SAFETY PROBLEM AREAS

In 1997, according to the National Highway Traffic Safety Administration (NHTSA), 5,307 pedestrians were killed in traffic crashes in the United States. On the average, a pedestrian is killed in a traffic crash every 97 minutes. And more than 100,000 pedestrians were seriously injured in traffic crashes. Most pedestrian crashes in 1996 occurred in urban areas (71 percent), at non-intersection locations (77 percent), in normal weather conditions (88 percent), and at night (65 percent). In larger cities, pedestrian fatalities may account for more than half of all traffic fatalities. More than two-thirds (69 percent) of the pedestrian fatalities were males. Although pedestrian crashes affect every age group, children and older adults face the greatest risk.<sup>15</sup>

Rates are the highest for 5- to 9-year-old males, which is related in part to the tendency of young children to dart into the street, and the complementary tendency of many drivers to ignore the likelihood of this kind of event and fail to slow down. Rates for older persons (65 and above) are lower than that for most age groups, which may reflect greater caution by older pedestrians. However, older adult pedestrians are much more vulnerable to serious injury or death when struck by a motor vehicle than are younger pedestrians.

Some of the more common characteristics of pedestrian crashes are listed below, along with details on their frequency.

<sup>12</sup>Federal Highway Administration, *Manual on Uniform Traffic Control Devices* (Washington, DC, 1988).

<sup>13</sup>Federal Highway Administration, *Older Pedestrian Characteristics for Use in Highway Design* (Washington, DC, 1994).

<sup>14</sup>Institute of Transportation Engineers, *Design and Safety of Pedestrian Facilities* (Washington, DC 1998).

<sup>15</sup>NHTSA, *Traffic Safety Facts 1997: Pedestrians* (Washington, DC, 1998)





**Figure 2.2**  
*Pedestrian  
Crashes by Age*

Age Group (years)	Total Traffic Fatalities	Pedestrian Fatalities	Percentage of Total Fatalities
0-4	788	165	21
5-9	815	240	29
10-15	1,554	239	15
16-20	5,757	300	5
21-24	3,781	253	7
25-29	3,884	336	9
30-34	3,481	421	12
35-39	3,432	468	14
40-44	3,000	454	15
45-49	2,570	404	16
50-54	2,097	297	14
55-59	1,649	238	14
60-64	1,488	250	17
65-69	1,524	242	16
70+	5,802	914	16
Unknown	345	86	--
<b>Total</b>	<b>41,967</b>	<b>5,307</b>	<b>13</b>

Age Group (years)	Total Traffic Injuries	Pedestrian Injuries	Percentage of Total Injuries
0-4	82,000	4,000	5
5-9	111,000	11,000	10
10-15	190,000	11,000	6
16-20	590,000	7,000	1
21-24	344,000	5,000	1
25-29	368,000	4,000	1
30-34	330,000	5,000	1
35-39	317,000	6,000	2
40-44	267,000	6,000	2
45-49	203,000	4,000	2
50-54	155,000	4,000	2
55-59	110,000	2,000	2
60-64	78,000	2,000	2
65-69	80,000	2,000	2
70+	175,000	5,000	3
<b>Total</b>	<b>3,399,000</b>	<b>77,000</b>	<b>2</b>

Source: NHTSA, 1997 *Traffic Safety Facts: Pedestrians* (Washington, DC, 1998)



---

## Common Characteristics of Pedestrian Crashes

- ◆ Driver inattention.
- ◆ Struck by vehicle while crossing at an intersection (50 percent of all crashes).
- ◆ Struck from behind while walking along the roadway in the same direction as motor vehicle traffic (particularly in rural areas at night).
- ◆ Motorist exceeding the safe speed (contributes to most pedestrian fatalities).
- ◆ Darting out into the street at mid-block (most common type of pedestrian crash involving children).
- ◆ Vehicles backing up (difficult to see children and others walking behind).
- ◆ Crashes in urban areas (80 percent of all crashes).

Source: Adapted from NHTSA, *Pedestrian and Bicycle Crash Types of the Early 1990s* (Washington, DC, 1995).

---

## Americans With Disabilities Act Requirements

The Americans with Disabilities Act (ADA) is a Federal law designed to ensure that all Americans have a same access to services and facilities. The ADA Accessibility Guidelines (ADAAG) have been developed and issued by the Architectural and Transportation Barriers Compliance Board (also called the Access Board).<sup>16</sup>

The ADA requires pedestrian facilities used by the general public to be planned, designed, constructed, and maintained with the understanding that a wide range of people, including people with disabilities, will be using them and relying on them for their daily travel. By providing pedestrian facilities that are fully accessible we enable people with various degrees of mobility and disability to be as self-sufficient and independent as possible.

The ADAAG applies only to new construction and reconstruction, but other legal requirements of ADA cover improvements to existing facilities, including removal of barriers in places of public accommodation.

Disabilities can take many forms and are a much more widespread condition that most people realize. When you consider such conditions as hearing and sight impairments, mobility limitations, and heart disease it is not surprising to learn that approximately 70 percent of all Americans will experience some form of disability at some point in their lifetimes, either temporarily or permanently.<sup>17</sup>

<sup>16</sup>For instance, see U.S. Architectural and Transportation Compliance Board (The Access Board), *Accessible Sidewalks: A Design Manual* (Washington, DC, 1997).

<sup>17</sup>American Institute of Architects Washington Council, *Accessibility Design for All, An Illustrated Handbook* (Olympia, WA, 1995).



## 2.2 ELEMENTS OF GOOD PEDESTRIAN PLANNING

There is a wide range of planning and design activities that takes place as part of the development of our communities. Local comprehensive plans, area plans, open space plans, transportation plans, site plans, zoning ordinances, and subdivision covenants impact the character, density and nature of our development. Together, they have a major effect in determining how walkable our neighborhoods and communities will be. Unfortunately, as the following comment by pedestrian authority Professor Richard Untermaier illustrates, we have not been treating walkability as a priority:

*“Over the last 40 years, as automobiles replaced street cars, the need for locating houses close to the streetcar stop disappeared. Retail business concentrated near the streetcar stop began to spread out randomly along the principal roads, as did residential subdivisions and apartment complexes... Curbs and sidewalks, symbols of a pedestrian and streetcar-oriented world, became expensive and unnecessary features in this new, low density environment. House lots became wider to accommodate garages, and houses themselves were set back from the street to reduce the noise and nuisance of passing cars.”<sup>18</sup>*

### RETHINKING THE ROLE OF TRANSPORTATION IN COMMUNITIES

One of the keys to creating walkable communities is to rethink our approach to development and planning. One approach is to develop communities that are oriented to a more balanced transportation system supporting automobiles, bicycles, transit, and walking. Such a “multi-modal” community would have all or most of the following kinds of features.

---

#### Qualities of Multi-Modal Communities

- ◆ A neighborhood center (providing retail and office uses) is located within 5 minutes walking distance, roughly a one-quarter mile radius for the majority of residents in the neighborhood.
- ◆ The streets are laid out in well-connected patterns, at a pedestrian scale, so that there are alternative automobile and pedestrian routes to every destination.
- ◆ The streets are treated as complex public spaces, containing traffic and parking, and they are an integral part of the “public realm,” including trees, sidewalks, and the buildings that front on them.
- ◆ The streets are relatively narrow, in order to discourage high-speed automobile traffic. Streetscapes should be well-defined by buildings and trees along them.

<sup>18</sup> Untermaier, Richard, *Linking Land Use and Transportation* (Seattle, University of Washington, 1991).



- ◆ On-street parking is permitted and provides an adequate supply of spaces. The cars act as additional buffers between pedestrians on the sidewalks and moving vehicles on the adjacent street. They also serve to slow down the passing traffic, helping to balance the overall use of the street.
- ◆ The buildings are generally limited in size, and building uses are often interspersed; that is, small houses, large houses, outbuildings, small apartment buildings, corner stores, restaurants, and offices are compatible in size and placed in close proximity.
- ◆ In addition to streets, there are squares that form public commons, around which are larger shops and offices, as well as apartments.

Source: “*Neo-Traditional Neighborhood Design and its Implications for Traffic Engineering*”, *ITE Journal* (Washington, DC, January 1992).

**CHARACTERISTICS  
OF WALKABLE  
COMMUNITIES**

The foregoing provides a vision of what a community might look like when designed to accommodate all the various modes of transportation. It is also helpful to consider the key characteristics of pedestrian-friendly communities. The following checklist details the kinds of things a community should do to ensure that it is walkable.

---

A Checklist  
for Creating  
Pedestrian-Friendly  
Communities

- ◆ **Continuous Systems/Connectivity.** Provide a complete system of interconnected streets, pedestrian walkways, and other pedestrian facilities to increase pedestrian travel.
- ◆ **Shortened Trips and Convenient Access.** Provide connections between popular origins and destinations, between dead-end streets or cul-de-sacs, or as shortcuts through open spaces.
- ◆ **Linkages to a Variety of Land Uses/Regional Connectivity.** Provide pedestrian circulation and access to shopping malls, transit, down town, schools, parks, offices, mixed-use developments, and other communities within the region.
- ◆ **Coordination Between Jurisdictions.** Put pedestrian facilities in place to meet current and future needs by ensuring close coordination between jurisdictions and other modes of transportation. Maintain close coordination and cooperation with the state transportation department.
- ◆ **Continuous Separation from Traffic.** In pedestrian-oriented areas, minimize or eliminate street and driveway crossings. Provide buffers from motor vehicles.
- ◆ **Pedestrian-Supportive Land-Use Patterns.** Use a grid street layout with short blocks in business districts and downtowns to enhance pedestrian mobility.



- ◆ **Well-Functioning Facilities.** Ensure adequate width and sight distance, accessible grades, and alignment to avoid blind corners for all pedestrian facilities. Make sure common problems, such as poor drainage, are avoided.
- ◆ **Designated Space.** Delineate, sign, and mark pedestrian facilities, as appropriate.
- ◆ **Security and Visibility.** Design walkways to ensure a secure environment for pedestrians. Lighting, increased visibility, open sight-lines, and access to police and emergency vehicles are important considerations.
- ◆ **Automobiles are Not the Only Consideration.** Design streets to accommodate all modes of transportation. Reduce or manage parking supply using methods that encourage walking.
- ◆ **Neighborhood Traffic Calming.** Design narrow streets lined with trees, install roundabouts (i.e., small traffic circles) and curb bulbs, and make use of other techniques to lower motor vehicle speeds and create safer, more pleasant conditions for pedestrians.
- ◆ **Accessible and Appropriately Located Transit.** Situate transit facilities adjacent to work, residential areas, shopping, and recreational facilities to encourage pedestrian trips. Transit stops and centers should typically be located in areas of supporting densities. Providing adequate pedestrian facilities to access transit is essential to its success as an alternate mode of travel.
- ◆ **Lively Public Places.** Provide secure, attractive, and active spaces as focal points for the community, where people can gather and interact (e.g., pedestrian pocket parks and plazas).
- ◆ **Character and Scenic Opportunities.** Preserve important cultural, historic, and architectural resources to help strengthen the community's heritage and provide attractive environments and scenic views to encourage pedestrian use.
- ◆ **Pedestrian Furnishings.** Provide furnishings, such as benches, restrooms, drinking fountains, artwork, architectural fountains (especially for play!), and other similar elements to create more attractive and functional environments for pedestrians.
- ◆ **Street Trees and Landscaping.** Provide street trees to bring a human scale to the street environment. Landscaping and flowers in planting strips or containers, and other areas help to soften surrounding hard edges of buildings and parking lots and add life, color, and texture to the pedestrian experience.
- ◆ **Proper Maintenance.** Provide frequent cleanup and repair on a regular basis to ensure continued use of areas by pedestrians.

Source: Adapted from Washington Department of Transportation,  
*Pedestrian Facility Guidebook* (Olympia, WA, 1997).



## 2.3 GOOD ROAD DESIGN

Most walking takes place on or adjacent to the “public way.” This is the area traditionally set aside in our communities to provide access to private property and to accommodate the movement of people and goods. It is also the area we have come to think of as roadways for motor vehicles. In fact, in many situations the “public way” has been completely consumed by travel lanes for motor vehicles, leaving those who would walk no safe place to do so. Pedestrians are not-and, perhaps, cannot be-prohibited from the public way, but they are given no choice but to walk in the roadway. And the vehicle codes requires them to walk facing traffic when walking in the street, so that they can get out of the way of the cars. The primary intent is not to provide for the safety of the pedestrian, but rather to reinforce that the pedestrian must yield the roadway to the car, even though no other place has been provided for walking.

This practice and other anti-pedestrian aspects of street and highway design need to be replaced with a more balanced approach of providing for a range of travel options. We need a commitment to ensure that the use of the public way is planned, designed, and operated in such a way as to provide for reasonable, safe use by all users: motor vehicles, bicycles, and pedestrians. What is needed is good road design.

---

### Rethinking Street Design

One of the most encouraging recent statements on street design is contained in a new report from the Institute of Transportation Engineers, *Traditional Neighborhood Development: Street Design Guidelines*. While intended to address the design of streets as part of the emerging form of development referred to as “traditional neighborhood development,” or TND, many of the points made in this report suggest rethinking the basic concept of street design, in general, and how to better accommodate pedestrians, in particular. Here are some of the points that have special relevance to good road design for pedestrians.

Street design involves the design of some of the most important and most used public spaces. This is especially true in the case of residential areas, neighborhood centers, and downtown commercial areas where the design approach must include the various needs of pedestrians, bicyclists, transit, motor vehicles; the street’s relationships to adjacent and future land uses; and where many factors must be compared, considered and decided in order to develop the final design solutions.

Children and other nondrivers are too often needlessly impacted by street design that is exclusively motorist-oriented. When a person cannot safely or conveniently travel to without a vehicle, even simple matters such as children’s recreation outside of the home become more rigidly scheduled due to travel coordination needs. By rethinking the design of streets it is possible to accommodate nonmotorist travel and replace some vehicular trips with nonvehicular trips, especially by walking.

Scale is a critical street design parameter. What this matter of scale equates to for the designers of streets is a new focus: instead of being



primarily concerned with and designing for vehicles and then ‘accommodating’ pedestrians and others, designers must consider the sometimes competing needs and impacts of each design parameter on all of the users of the street. Successful street design in accordance with more pedestrian-friendly principles should result in a larger than usual number of pedestrians in the makeup of the users of the street. However, the pedestrians must obviously share the street with bicyclists, transit vehicles, passenger cars, trucks, and emergency vehicles. All of these users and occupants of the street will require a careful balancing of competing design factors.

---

## Pedestrian-Friendly Streets

Given all of the above, what, then, are the elements of pedestrian-friendly streets? A partial list is presented below. Not surprisingly, it shares many details with the checklist for pedestrian-friendly communities presented in section 2.2. This is as it should be: streets are one of the most significant elements of our communities. How they are planned and designed generally determines how walkable the community or neighborhood will be.

---

## Typical Elements of Pedestrian-Friendly Streets

- ◆ Streets that are interconnected and small block patterns that provide good opportunities for pedestrian access and mobility.
- ◆ Narrower streets, scaled down for pedestrians and less conducive to high motor vehicle speeds.
- ◆ Traffic-calming treatments to help ensure that motor vehicles are operated at or below compatible speeds.
- ◆ Wide and continuous sidewalks that are fully accessible, that maintain a fairly level cant, and that are well maintained.
- ◆ Well-designed intersections to ensure easy, safe crossings by pedestrians of all ages and abilities.
- ◆ Well-designed and marked crosswalks, both at intersections and, where needed, at mid-block locations.
- ◆ Appropriate use of signs and signals for both pedestrians and motorists, with equitable treatment for pedestrians.
- ◆ Median islands on wider streets to provide a refuge area for crossing pedestrians.
- ◆ Street lighting designed to pedestrian scale (e.g., shorter light poles and/or lower light fixtures that are designed to be effective in illuminating the pedestrian travel way).
- ◆ Planting buffers, with landscaping and street trees that provide shelter and shade without obstructing sight distances.
- ◆ Street furnishings and public art intended to enhance the pedestrian experience, such as benches, trash receptacles, drinking fountains, and newspaper stands, placed so as not to interfere with pedestrian travel.

Source: Adapted From Washington DOT, *Pedestrian Facilities Guidebook*.



## SECTION 3

### Design principles

#### The where and when of sidewalks and walkways definitions

#### Designing sidewalks and walkways

#### Corners

#### Intersections and Crossings

#### Sidewalk management and maintenance

RETURN TO  
TABLE OF CONTENTS

### 3.1 DESIGN PRINCIPLES

This section looks at how to design facilities for pedestrians along and across streets and highways. This includes sidewalks and walkways, street corners and intersections, and street and driveway crossings. It includes recommendations on how to design these features and attempts to take into account the wide range of community types and sizes that make up the Kansas City metropolitan area. For instance, while it may be desirable and even necessary to have sidewalks 12 to 16 feet wide in commercial areas in downtown Kansas City, 5 feet may be the appropriate width for sidewalks in a neighborhood in Liberty.

The guidance provided in this section on the design of pedestrian facilities is just that: guidance. Each jurisdiction should review the suggestions—many of them from organizations such as the Institute of Transportation Engineers (ITE), or based on research sponsored by the Federal Highway Administration (FHWA), or taken from guidelines developed by some of our country’s most walkable communities and cities—and determine what changes you may want to make to help make your neighborhoods and commercial areas more pedestrian friendly and walkable.

Pedestrians are an integral part of every community’s transportation system. The importance of good pedestrian facility design not only applies to development of new facilities, but also to the improvement and retrofitting of existing facilities for pedestrian use. Research has shown that providing well-designed and maintained pedestrian facilities encourages walking and promotes higher levels of pedestrian travel.<sup>20</sup>

Pedestrians want facilities that are safe, attractive, convenient, and easy to use. Unattractive, inadequate, and poorly designed and maintained facilities can be a waste of money and resources and a hindrance to community vitality. Pedestrian needs and facilities should be considered at the inception of all public and private projects and addressed as part of the total design solution.

In developing facilities for pedestrians, it is useful to consider a set of guiding design principles that speaks to the needs of pedestrians and the general means by which these needs are to be met. The following design principles represent a set of ideals for every pedestrian improvement. They are listed roughly in terms of relative importance.

<sup>20</sup> Knoblough, R. L., B. H. Tustin, S. A. Smith, and M. T. Pietrucha, *Investigation of Exposure Based Pedestrian Areas: Crosswalks, Sidewalks Local Streets and Major Arterials*, Federal Highway Administration (Washington, DC, 1988).





---

## Principles for Pedestrian Design

- ◆ The pedestrian environment should be safe. Sidewalks, walkways, and crossings should be designed and built to be free of hazards and to minimize conflicts with external factors such as noise, vehicular traffic, and protruding architectural elements.
- ◆ The pedestrian network should be accessible to all. Sidewalks, walkways, and crosswalks should ensure the mobility of all users by accommodating the needs of people regardless of age or ability.
- ◆ The pedestrian network should connect to places people want to go. The pedestrian network should provide continuous direct routes and convenient connections between destinations, including homes, schools, shopping areas, public services, recreational opportunities, and transit.
- ◆ The pedestrian environment should be easy to use. Sidewalks, walkways, and crossings should be designed so people can easily find a direct route to a destination and minimize delays.
- ◆ The pedestrian environment should provide good places. Good design should enhance the look and feel of the pedestrian environment. The pedestrian environment includes open spaces such as plazas, courtyards, and squares, as well as the building facades that give shape to the space of the street. Amenities such as street furniture, banners, art, plantings, and special paving, along with historic elements and cultural references, should promote a sense of place.
- ◆ The pedestrian environment should be used for many things. The pedestrian environment should be a place where public activities are encouraged. Commercial activities such as dining, vending, and advertising may be permitted when they do not interfere with safety and accessibility.
- ◆ Pedestrian environments should be economical. Pedestrian improvements should be designed to achieve the maximum benefit for their cost, including initial cost and maintenance cost as well as reduced reliance on more expensive modes of transportation. Where possible, improvement in the right-of-way should stimulate, reinforce, and connect with adjacent private improvements.

Source: Based on City of Portland, Office of Transportation, *Pedestrian Design Guide* (Portland, OR, 1998).



3.2  
THE WHERE AND WHEN  
OF SIDEWALKS AND  
WALKWAYS  
DEFINITIONS

**Sidewalks.** Sidewalks are typically constructed of concrete, are raised and located adjacent to curbs or separated from the curb by a linear planting strip. Sidewalk widths can vary, but typically they should be a minimum of 5 feet wide (clear width) on local residential streets, and can be 6 to 15 feet on collector and arterial streets, or sometimes wider in special districts.

**Walkways.** In contrast to sidewalks, which are typically raised, walkways are usually built over the existing ground surface without being raised. Instead of vertical separation by curb and gutter, walkways are usually separated horizontally by a planting buffer or ditch. In some cases, extruded curbs or barriers are used to separate a walkway from adjacent street traffic. Walkways are often constructed of materials other than concrete, such as asphalt or compacted granular stone or crushed rock. Walkway width can vary, but the minimum recommended width is five feet. When horizontally separated, the minimum separation distance recommended between the edge of the street and a walkway is 5 feet.

**Shoulders.** Roadway shoulders can serve as suitable walkways in rural areas if designed properly, especially if the alternative is no pedestrian travel area at all.

---

Location

A recent study confirmed that higher numbers of pedestrians can be found in areas where more complete and continuous sidewalks, walkways, crossings and other pedestrian facilities exist.<sup>21</sup> There is a need to increase the general level of pedestrian facilities in our communities, including the available network of sidewalks and walkways. Even if there does not appear to be a current demand for pedestrian facilities, pedestrian travel can almost always be expected to increase when facilities are provided. For this reason, it is recommended that at least some type of pedestrian travel way be provided along all streets and highways.

It is recognized that development of pedestrian facilities on all streets will take time (especially where it is necessary to retrofit them into existing neighborhoods). Most communities will look for ways to gradually add pedestrian facilities on a street-by-street basis. Some may undertake a more ambitious program to add sidewalks to at least one side of every residential street within the period of a few years.

<sup>21</sup> Vernez-Moudon, Anne, *Effects of Site Design on Pedestrian Travel in Mixed-Use Medium Density Environments*, University of Washington College of Urban Planning (Seattle, WA, 1996).



---

## Guidelines for Sidewalks

Determining when and where sidewalks are needed is typically done by each local jurisdiction. The American Association of State Highway and Transportation Officials (AASHTO) provides the following guidance:

- ◆ Develop sidewalks as integral parts of all city streets.
- ◆ If pedestrian activity is anticipated, construct sidewalks as part of street development.
- ◆ Give consideration to connecting the nearby urban communities with sidewalks, even though pedestrian traffic may be light.
- ◆ Sidewalks in rural and suburban areas are needed at schools, local businesses, and industrial plants that result in pedestrian concentrations (and at parks, office buildings, and in all residential areas).
- ◆ In general, whenever the roadside and land development conditions are such that pedestrians regularly move along a main or high-speed highway, they should be furnished with a sidewalk or path area, as suitable to the conditions.
- ◆ The higher speeds of traffic and general absence of lighting in rural areas reinforce the need for sidewalks. Available data suggest that sidewalks in rural areas reduce pedestrian/motor vehicle collisions.
- ◆ As a general practice, sidewalks should be constructed along any street or highway not provided with shoulders, even though pedestrian traffic may be light. Sidewalks built along rural highways should be well removed from the traveled way, separated by a ditch or as much space as available within the right-of-way.

Source: AASHTO, *A Policy on Geometric Design of Highways and Streets* (Washington, DC, 1994).

In most cases, it is desirable to provide sidewalks on both sides of major streets used by pedestrians. Providing sidewalks on both sides enables pedestrians to travel facing traffic in either direction and minimizes the need for pedestrians to cross streets. Also, sidewalks also serve as social and recreational facilities and thus serve a function in front of any residential property. Finally, sidewalks are a key element in fulfilling the accessibility requirements of the ADA, including access to properties and transit service.



A sidewalk on one side may be adequate for some local streets, especially when this improves a condition where there were no sidewalks previously (e.g., retrofitting existing neighborhood streets). In such situations, several factors influence the decision of whether to place sidewalks, walkways, and widened shoulders on both sides or one side (and which side). These factors include the available space within the right-of-way, the existing physical limitations at the roadside, and pedestrian circulation patterns. Walkways should be located on the same side of the street as key origins and destinations such as schools and bus stops (to reduce the need for crossing streets).

The new ITE pedestrian facilities guide includes a Recommended Practice: Recommended Guidelines for Sidewalk Installation. It is recommended that these guidelines be adopted by local jurisdictions in the Kansas City metropolitan area.

*“It is recommended that local and state agencies adopt guidelines for the location and installation of pedestrian facilities consistent with the Americans with Disabilities Act (ADA) rules. Recommended general sidewalk requirements should be based upon land use, roadway functional classification and, in the case of residential areas, dwelling unit density as detailed in [see Table 3.1]:”*

**Table 3.1**  
*Recommended Guidelines for Sidewalk Installation*

*Source: ITE, Design and Safety of Pedestrian Facilities.*

**NOTES:**

1. Any local street within two blocks of a school site that would be on a walking route to school—sidewalk and curb and gutter required.
2. Sidewalks may be omitted on one side of a new street where that side clearly cannot be developed and where there are no existing or anticipated uses that would generate pedestrian trips on that side.
3. Where there are service roads, the sidewalk adjacent to the main road may be eliminated and replaced by a sidewalk adjacent to the service road on the side away from the main road.
4. For rural roads not likely to serve development, a shoulder at least 4 feet in width, preferably 8 feet on primary highways, should be provided. Surface material should provide a stable, mud-free walking surface.

Land-Use/Roadway Functional Classification & Dwelling Unit	New Urban and Suburban Streets	Existing Urban and Suburban Streets
Commercial and Industrial (All Streets).	Both sides.	Both sides. Every effort should be made to add sidewalks where they do not exist and complete missing links.
Residential (Major Arterials).	Both sides.	Both sides.
Residential (Collectors).	Both sides.	Multi-family — Both sides.  Single family dwellings — prefer both sides; require at least one side.
Residential (Local streets) More than 4 Units per Acre.	Both sides.	Prefer both sides; require at least one side.
1 to 4 Units per Acre.	Prefer Both sides; require at least one side.	At least 4-foot shoulder on both sides required.
Less than 1 Unit per Acre.	One side preferred; shoulder on both sides required.	One side preferred; at least 4-foot shoulder on both sides required.



### 3.3 DESIGNING SIDEWALKS AND WALKWAYS

This section provides guidelines for the design of what we tend to think of as the “sidewalk,” or that element of the pedestrian environment that goes along streets and highways. The Portland Pedestrian Design Guide offers a somewhat broader concept in defining the Sidewalk Corridor as “the portion of the pedestrian system from the edge of the roadway to the edge of the right-of-way, generally along the sides of streets, between street corners.” The guide presents a list of attributes of good sidewalk corridors that is very helpful in reminding us why we want sidewalks and what they are intended to accommodate.

---

#### Attributes of Good Sidewalk Corridors

##### ***Accessibility.***

The Sidewalk Corridor should be easily accessible to all users, whatever their level of ability.

##### ***Adequate Travel Width.***

In most areas, two people walking together should be able to pass a third person comfortably, and different walking speeds should be possible. In areas of intense pedestrian use, sidewalks should be wider to accommodate the greater volume of walkers.

##### ***Safety.***

Sidewalk Corridors should allow pedestrian to feel a sense of safety and predictability. Sidewalk users should not feel threatened by adjacent traffic.

##### ***Continuity.***

The walking route along a Sidewalk Corridor should be obvious and should not require pedestrians to travel out of their way unnecessarily.

##### ***Landscaping.***

Plantings and street trees in the Sidewalk Corridor should create desirable microclimates and should contribute to the psychological and visual comfort of sidewalk users.

##### ***Social Space.***

Sidewalk Corridors should provide places for people to interact. There should be places for standing, visiting, and sitting. The Sidewalk Corridor should be a place where children can safely participate in public life.

##### ***Quality of Place.***

Sidewalk Corridors should contribute to the character of neighborhoods and business districts, and strengthen their identity.

Source: City of Portland, Office of Transportation, *Pedestrian Design Guide*.



## ACCESSABILITY

The design of sidewalks is covered by the ADA Interim Final Rule for State and Local Government Facilities issued by the Architectural and Transportation Barriers Compliance Board on June 20, 1994.

---

### ADA Provisions Affecting Improvements in the Public Right-of-Way

- ◆ A minimum clear passage of 36 inches is required; and when public sidewalk width is less than 60 inches, 5-foot-square “passing areas” are required at intervals not to exceed 200 feet.
- ◆ There is no limit on running slope nor a requirement of intermediate landings (“passing areas”) for a public sidewalk when it follows the grade of the street.
- ◆ The maximum cross slope of 1:50 is allowed for a sidewalk.

Source: Architectural and Transportation Barriers Compliance Board, *Interim Final Rule for State and Local Government Facilities, Federal Register*, 59 (121), 36 CFR Part 1191.

## WIDTH AND SETBACK

The recommended minimum sidewalk width is 5 feet exclusive of curb and obstructions. This width allows two pedestrians (including a wheelchair user) to walk side by side, or to pass each other comfortably. It also allows two pedestrians to pass a third pedestrian without leaving the sidewalk. While most communities in metropolitan Kansas City currently require 4-foot-wide sidewalks in single-family subdivisions, that width should be used only when development constraints exist or very low usage is forecast.

This 5-foot width is consistent with the minimum sidewalk widths proposed by ITE:

*“The following are suggested minimum specifications for the width of the sidewalk to be installed. When determining the appropriate sidewalk width, it is important to consider that the effective sidewalk width for pedestrian movement is most urban environments is reduced by parking meters, planters, mail boxes, light poles, signs, and other street furniture. The minimum widths shown below are exclusive of these effective width-reducing appurtenances.”*

---

### Recommended Minimum Sidewalk Widths

**Central business district:** Wide enough to meet desired level of service according to methods in the 1994 Highway Capacity Manual. The minimum width should be 8 feet.

**Commercial/Industrial area outside the central business district:** Minimum 5 feet wide with 2-foot planting strip or 7 feet wide with no planting strip. However, wider planting strips of 4 or 5 feet are recommended when possible.

**Residential area outside the central business district:** Arterial and collector streets - Minimum 5 feet wide with minimum 2-foot planting strip.



**Local streets:** Multifamily dwellings and single-family dwellings with densities greater than four dwelling units per acre - Minimum 5 feet wide with minimum 2-foot planting strip. Densities up to four dwelling units per acre - Minimum 4 feet wide with minimum 2-foot planting strip.

Source: ITE, *Design and Safety of Pedestrian Facilities*.

Where there is adequate space, wider planting strips are desirable. Pedestrians are sensitive to fixed and moving objects adjacent to their path. Separation from adjacent roadways and other features is an important consideration. A setback of 4 to 8 feet from the roadway edge provides a buffer between parked and moving automobiles, and provides for other benefits:

---

## Other Setback Benefits

- ◆ Space for landscaping features: trees, shrubs and other plantings.
- ◆ Room for utility and lighting poles, signposts, parking meters, trash receptacles and fire hydrants.
- ◆ Room for the temporary storage of leaves and snow.
- ◆ Direct alignment of sidewalks with curb ramps and crosswalks at intersections.
- ◆ Room to accommodate driveway ramping while maintaining level sidewalk cross-slope.

Sidewalk setbacks may vary according to adjacent roadway configuration and land use. While setbacks of 3 to 4 feet are common in residential areas and along low volume streets, as vehicle speeds and the percentages of truck traffic increase, setback distances should ideally increase 4 to 8 feet to provide a buffer for pedestrians from wind blast, noise, and for increased comfort.

## CLEARANCE AND SHY DISTANCE

The minimum sidewalk clearance under any set of conditions is 3 feet, with a minimum of 6 feet in downtown commercial areas. “Clearance” means the area is clear of obstructions such as sign posts, utility and signal poles, mailboxes, traffic signal control boxes, parking meters, fire hydrants, trees, planters, newspaper vending machines, and street furniture. These kinds of obstructions should be placed between the sidewalk and the roadway to help create a buffer for increased pedestrian comfort. At the same time, care must be taken not to impair the visibility of motorists, such as when they are exiting a driveway or parking lot.

The vertical clearance recommended for sidewalks and walkways is typically 8 feet. For items such as traffic signs located directly adjacent to or within the sidewalk and tree branches, there should be at least 7 feet of clearance from ground level to the bottom of the sign or to the lowest branches.

A shy distance of 2 to 3 feet should be allowed for shoulder-high barriers such as building walls, railings, and fences. In the case of bridges, a



sidewalk width of at least 7 feet is recommended to allow for shy distance from the bridge rail.

Finally, cars parked perpendicular or diagonally to sidewalks can be obstructions if there is excessive overhang. Blocks should be used to prevent intrusion into the sidewalk width.

## GRADE, CROSS-SLOPE AND VERTICAL ALIGNMENT

Sidewalks follow the general terrain of the street right-of-way, but sidewalk design and construction should minimize any negative impact the terrain might have on accessibility. The ADA Accessibility Guidelines<sup>22</sup> detail specific parameters as follows:

### ◆ **Cross-Slope.**

Excessive cross-slope is the single greatest barrier to travel along sidewalks for pedestrians who use wheelchairs... walkers and crutches... lower limb prostheses, and those with gait, balance and stamina impairments... Cross slopes that exceed 2 percent (1:50) significantly impede forward progress on an uphill slope and compromise control and balance in downhill travel and turns.

### ◆ **Running Slope.**

On a site, a thoughtful designer can manipulate cut and fill, entrance and location, and approach direction and length so as to limit walkway running slope to the 5 percent (1:20) specified in the ADAAG. Where topography requires it, a ramp-with landings and handrails-can connect levels at a maximum slope of 8.33 percent (1:12). These limitations will not always be possible to achieve along sidewalks, where running slope is tied to roadway gradient and underlying terrain. Running slope on sidewalks should be kept to the minimum feasible consistent with these factors.

### ◆ **Vertical Alignment.**

ADAAG provisions for an accessible route limit allowable vertical differences in level between abutting surfaces to no more than 1/4 inch (1/2 inch if beveled at 1:2). While it may not be feasible to meet new construction criteria consistently along older sidewalks, agencies and entities responsible for sidewalks should note that the Department of Justice regulation includes requirements for the maintenance of accessible features.

## SURFACES

The preferred material for sidewalks is Portland cement concrete (PCC), which provides a smooth, durable finish that is easy to grade and repair. Asphaltic concrete (A/C) may be used if it can be finished to the same surface smoothness as PCC. A/C is susceptible to breakup by vegetation, requires more frequent maintenance and generally has a shorter life expectancy (15-20 years versus 40 years or more for PCC).

<sup>22</sup> Architectural and Transportation Barriers Compliance Board, *Accessible Rights-of-Way, Bulletin #7* (Washington, DC, 1994).





Any material used for sidewalks and walkways needs to be slip-resistant and easy to maintain (smooth for snow removal and able to resist buckling and cracking). Surfaces must be accessible, which is accomplished by meeting the “stable, firm, and slip-resistant” criteria of the ADA design guidelines.

Special districts and downtown streets often incorporate special paving into the design of sidewalks and pedestrian areas, such as stamped or colored concrete, brick, or other unit pavers. Brick and unit pavers need to be installed in a way that provides a smooth level surface. In rural areas, alternative surfacing, such as compacted crushed rock or unpaved compacted earth, may also be acceptable for certain walkways. These surfaces are typically not accessible to people using strollers or wheelchairs unless very smooth and well-compacted.

## **ROADWAY SHOULDERS AS WALKWAYS**

Wide shoulders along roadways can also serve as walkways, particularly in rural areas. In rural areas, where funding for pedestrian improvements may be limited, walkways on shoulders may be acceptable as a long-term solution, particularly if the alternative is no pedestrian facilities at all.

A 3- to 5-foot-wide shoulder on local roads with lower traffic volumes (less than 400 ADT) and lower speeds (less than 40 mph) may provide sufficient walk space for a single pedestrian. At least a 6-foot-wide shoulder is recommended when traffic volume and/or speed exceeds these values. Generally, the shoulder widths recommended by AASHTO will serve to accommodate simple pedestrian use.<sup>23</sup>

But shoulders that accommodate groups of pedestrians, such as school children walking to and from school or from a school bus stop, and that are located on major collector and arterials streets, need to be wider. At a minimum, 6-foot-wide shoulders should be provided on both sides of the road for school walk routes or at least 8 feet wide if constructed on only one side (generally, a practice to be avoided).

Shoulders may be paved or unpaved. A high visual and tactile contrast is desirable in order to clearly define the pedestrian area and discourage drivers from straying onto the shoulder. If paved shoulders are to be used by pedestrians, they should be well marked. One design solution that helps delineate the shoulder walking area is the use of a contrasting paving material or color for the paved shoulder, or a contrasting strip separating the shoulder from the street.

Shoulders are not really appropriate as accessible routes of travel. In areas where an accessible route of travel is needed along the roadway to provide access between public buildings or facilities, a full sidewalk or walkway improvement, raised and separated from the street, should be constructed.

<sup>23</sup> AASHTO, *A Policy on Geometric Design of Highways and Streets* (Washington, DC, 1994).



Shoulders that are intended to be used by pedestrians should not be used as roadside parking lanes, not even for short-term or temporary periods (except during emergencies).

Special attention must be given to snow removal from shoulders. Frequently, and for a variety of reasons, more people tend to walk when there are snow conditions. In areas with no sidewalks (or where sidewalks are not cleared in a timely manner), pedestrians will walk on the shoulder or on the roadway. Snow removal programs should call for providing a clear shoulder just as they do for travel lanes on the roadway. Further, care must be taken not to reduce sight distance at intersections and corners by piling snow too close to the walkway.

---

## Recommendations for Walking Shoulders

- ◆ Best used in rural areas with lower pedestrian volumes.
- ◆ A 3- to 5-foot minimum width along roadways with less than 400 ADT.
- ◆ A 6-foot minimum width, on both sides of the roadway, for school and school bus walking routes.
- ◆ An 8-foot minimum width, on at least one side of the roadway, for school and school bus walking routes, with over 2,000 ADT.
- ◆ Shoulders can be paved or unpaved, but high visual and tactile contrast from the adjacent roadway is desirable.
- ◆ Parking should be prohibited on shoulders intended to serve as a pedestrian walkway.

## 3.4 CORNERS

**P**edestrians and pedestrian activities tend to cluster at street corners. These are the places where sidewalks converge, where walkers wait for opportunities to cross, and where sidewalks most often make a connection with a street. Corners are by their nature busy areas. They are the typical location for street name signs, traffic control devices, and far too many vending machines! The design of corners affects the speed of both through and turning motor vehicles. And visibility at the corner is an issue for all users of the street system.

---

## Attributes of Good Street Corners for Pedestrians

**Clear Space.** Corners should be clear of obstructions, and have enough space to accommodate the typical number of pedestrians waiting to cross. They should also have enough room for curb ramps, for transit stops where appropriate, and for street conversations.

**Visibility.** It is critical that pedestrians on the corner have a good view of the travel lanes and that motorists in the travel lanes can easily see waiting pedestrians.



**Legibility.** Symbols, marks, and signs used at corners should clearly indicate what actions the pedestrian should take.

**Accessibility.** All corner features, such as ramps, landings, call buttons, signs, symbols, marks and textures must meet accessibility standards.

**Separation from Traffic.** Corner design and construction must be effective in discouraging turning vehicles from driving over the pedestrian area.

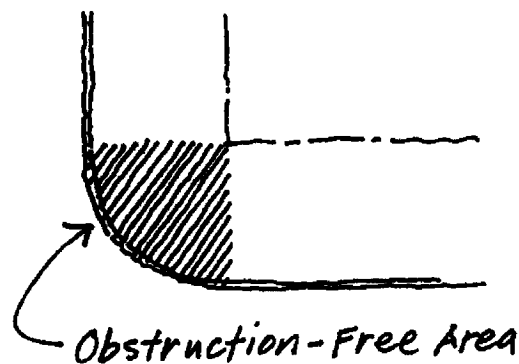
Source: City of Portland, Office of Transportation, *Pedestrian Design Guide*.

## OBSTRUCTION-FREE AREA

Since corners must accommodate concentrations of pedestrians and pedestrian activities, and since sight lines need to be maintained for all street users, it is important to maintain corner areas free of obstructions. For this purpose, the “obstruction-free area” can be defined as the space between the curb and the lines created by extending the property lines (or the line of the public way easement) to the curb face (see figure 3.1). Items such as signal poles, street lights, telephone poles and telephones, hydrants, trees, benches, signs, controller boxes, and newspaper boxes should not be located within this area.

**Figure 3.1**  
*Obstruction-Free Area*

(The obstruction-free area of a street corner is the space between the curb and the lines created by extending the property line to the curb face.)



Source: City of Portland, Office of Transportation, *Pedestrian Design Guide*.

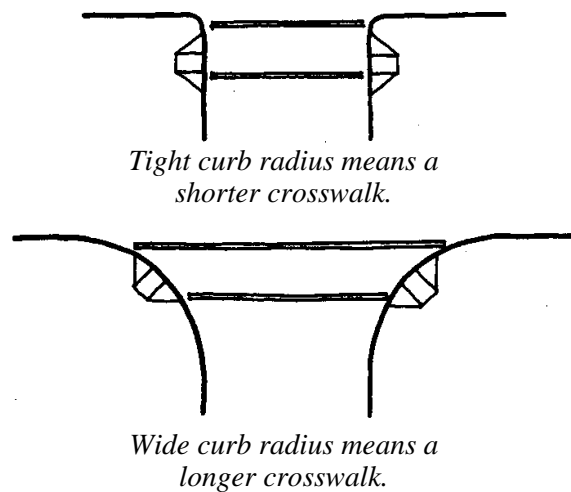


## CURB RETURN RADIUS

Historically, design of curb return radii at intersections has focused primarily on accommodating higher speed turns by motor vehicles and not on the needs and safety of pedestrians. With new intersection development and retrofits to existing intersections, it is important to consider the needs of all users, to balance these needs, and to select designs that provide the safest operating conditions for all.

In general, the smaller the curb radius, the better for the pedestrian. In comparison to a large curb radius, a tight curb radius provides more pedestrian area at the corner, allows more flexibility in the placement of curb ramps, results in a shorter crosswalk, and requires vehicles to slow more as they turn the corner (see figure 3.2).

**Figure 3.2**  
*Examples of Curb  
Return Radius*



Source: City of Portland, Office of Transportation, *Pedestrian Design Guide*.

The need for shorter pedestrian crossing distances and reduced vehicle speeds needs to be balanced with the need to provide adequate curb radius lengths to accommodate the types of vehicles that turn at the intersection. A radius that is too small can cause large vehicles and buses to jump the curb, causing deterioration of the curb and intrusion into the waiting and standing space for pedestrians. On the other hand, there appears to be a continuing trend to the use of larger and larger trucks for such functions as garbage pickup, household moving, emergency vehicles, utility service, and general delivery. The fact is, these vehicles are not appropriately sized for many neighborhood streets.

As a consequence, the streets are either designed wider than is otherwise warranted with large curb return radii, or the drivers typically just ignore the curb and drive over it (rather than making the effort to negotiate the turn) and break curbs and ruin lawns and landscaping.

Still, it is not always practical to reduce the curb return radii at all intersections used by pedestrians, particularly at existing intersections. But at intersections where there is heavy pedestrian crossing activity and



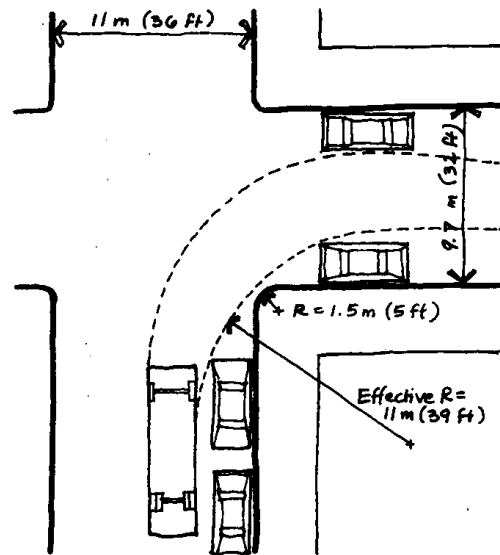
limited truck and bus turning movements, it may be desirable to shorten the radius by adding curb extensions or bulb-outs (see figure 3.6). It may also be desirable to analyze transportation routes in the area and to reroute trucks onto streets that receive less pedestrian use.

If truck and bus turning activity occurs at a minimal level, AASHTO allows a 15- to 25-foot curb radii on minor streets. On major streets, AASHTO allows a minimum turning radius of 30 feet if the occasional truck can turn with minimal encroachment. These standards may vary at the local level. In some cases, local jurisdictions may encourage the use of shorter-than-standard curb radii at intersections where there is likely to be frequent pedestrian crossing activity.

Several factors should govern the choice of curb radii in any given location. These include the desired pedestrian area of the corner, traffic turning movements, the turning radius of the design vehicle, the geometry of the intersection, the street classification, and whether there is parking or a bike lane (or both) between the travel lane and the curb (see figure 3.3).

The designer must balance all the factors, keeping in mind that the chosen radius should be the smallest possible for the circumstances. The radius may be as small as 3 feet where there are no turning movements, or 5 feet where there are turning movements and there is adequate street width and a larger effective curb radius created by parking and/or bike lanes.

**Figure 3.3**  
*Effect of Parking on Curb Radius*



*Where there is an effective curb radius sufficient for turning vehicles, the actual curb radius may be as small as 1.5 meters (5 feet).*

Source: City of Portland, Office of Transportation, *Pedestrian Design Guide*.



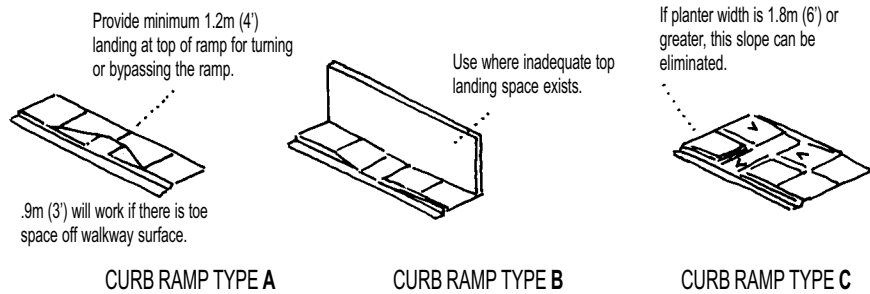
Curb return radii greater than 30 feet are not desirable at urban intersections where there are high numbers of pedestrians crossing. However, it may be necessary to provide a 30 foot radius or larger at some urban intersections where large trucks and/or buses turn frequently.

**SIDEWALK CURB RAMPS<sup>24</sup>**

Sidewalk curb ramps are the design elements that allow all users to make the transition in grade from the raised sidewalk to the street. There are a number of factors to be considered in the design and placement of curb ramps at corners.

**Ramps and Landings.** The ADA defines two types of curb ramp systems: “perpendicular ramps” and “parallel ramps” (see figure 3.4). The first has a ramp into a crosswalk, while the second has a ramp into a landing that is flush with the street surface (sometimes called a “dropped landing”). The basic principle is that every ramp must have a landing at the top and at the bottom. The maximum ramp slope in the right-of-way is 1:12 with a cross slope of no more than 1:50. The minimum width of a ramp is 3 feet. The landing at the top of a ramp should be at least 4 feet long and at least the same width as the ramp itself. It should slope no more than 1:50 in any direction.

**Figure 3.4**  
*Ramps and Landings/  
Accessible Sidewalk  
Curb Ramp Designs*



Source: Washington Department of Transportation, *Pedestrian Facility Guidebook*.

If the ramp runs directly into a crosswalk, the landing at the bottom will be in the roadway. The landing, 4 feet long, should be completely contained within the crosswalk and should not have a running slope of greater than 1:20. If the ramp lands on a dropped landing within the sidewalk or corner area where someone in a wheelchair may have to change direction, the landing must be a minimum of 5 feet long and at least as wide as the ramp, although a width of 5 feet is preferred. **Texture of Ramp Surfaces.** Ramps and dropped landings that lead directly to the roadway should have a surface that is finished with a heavy brooming pattern parallel to the curb.

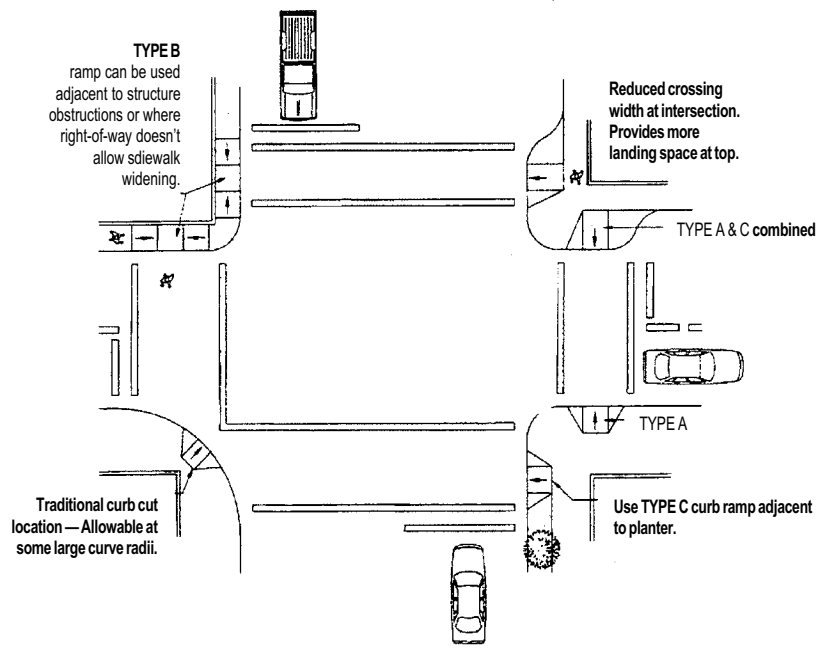
**Number of Ramps.** Ideally, there should be a separate curb ramp for each crosswalk at a corner; that is, two ramps at most corners. It is also

<sup>24</sup> Adapted from City of Portland, *ibid*.



**Figure 3.5**  
**Sidewalk Curb Ramps**  
**at Intersection**

Source: Washington Department of Transportation, *Pedestrian Facility Guidebook*.



preferred to use curb ramps rather than dropped landings. However, there are a number of factors that influence the number and design of curb ramps at a corner, including sidewalk width, corner radius, adjacent materials, and crosswalk location (see figure 3.5).

**CURB EXTENSIONS**  
**AND BULB-OUTS**

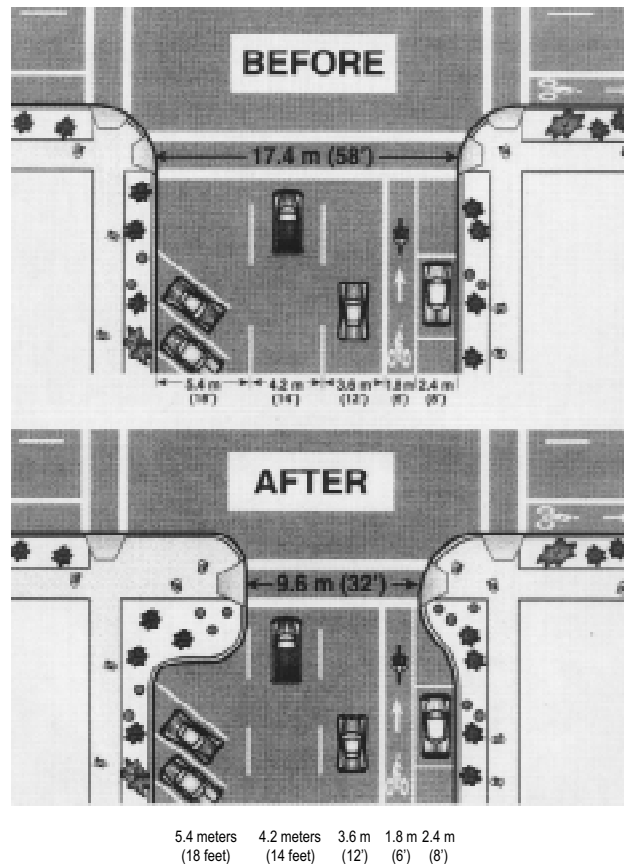
Curb extensions—also known as “bulb-outs, neckdowns, flares, or chokers”—reduce the pedestrian crossing distance and improve the visibility of pedestrians by motorists. Curb extensions should be considered at all intersections where on-street parking is allowed. The crossing distance savings are greatest when used on streets with diagonal parking. On arterials and collectors, space should be provided for existing or planned bicycle lanes.

Curb extensions and bulb-outs work particularly well on urban streets where there is limited turning traffic by buses and large vehicles, or streets that accommodate one-way traffic, and on minor streets in residential areas. Curb extensions typically have the effect of reducing the curb return radius.

Reducing pedestrian crossing distance improves signal timing if the pedestrian phase controls the signal. The time saved is substantial when two corners can be treated with curb extensions.

**Figure 3.6**  
*Curb Extensions*

Source: Oregon Department of Transportation, *Oregon Bicycle and Pedestrian Plan* (Salem, OR, 1995).



Nonsignalized intersections and mid-block crossings also benefit from curb extensions inasmuch as reducing the time pedestrians are in the crosswalk lessens exposure and improves pedestrian safety (see fig. 3.6).

#### DRIVEWAYS

Access to private property can be built as conventional driveways or with designs that resemble street intersections (see figure 3.7). For pedestrian safety and comfort, the conventional driveway type is preferred for the following reasons: 1) motorists must slow down more when turning into the driveway; and 2) the right-of-way is clearly established as motorists cross a sidewalk.

Intersection-type driveways have the following disadvantages for pedestrians: 1) motorists can negotiate the turn at faster speeds; and 2) the right of way is not as clearly established, as the roadway appears to wrap around the curb line.

Where an intersection-style driveway is used (such as to implement a “right-in, right-out” policy, see figure 3.8), the following techniques can be used to alleviate the above concerns.

- ◆ The street surface material should not carry across the driveway; rather, the sidewalk should carry across the driveway, preferably at sidewalk height, so motorists know they are entering a pedestrian area.





---

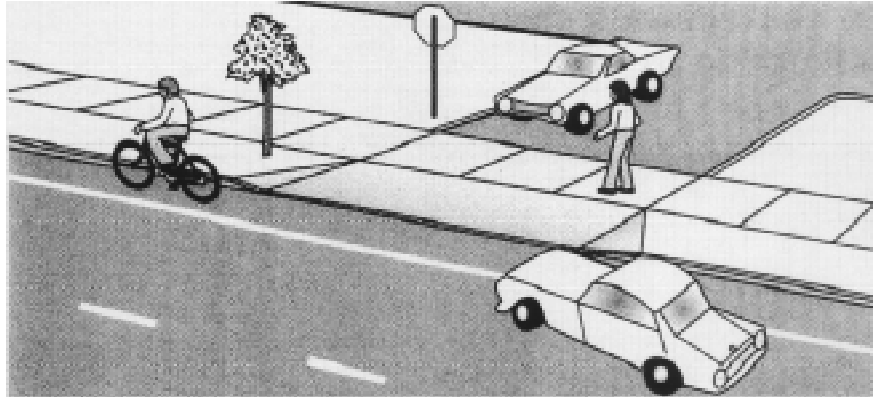
## Design of Intersection-Style Driveway

- ◆ The radius of the curb should be kept as small as possible.
- ◆ Driveway widths should be the minimum needed for entering and exiting vehicles.
- ◆ Where the volume of turning vehicles is high, right-turn channelization should be considered, to remove slower turning vehicles from the traffic flow, allowing them to stop for pedestrians; or a traffic signal should be considered where the turning movements are very high.

---

**Figure 3.7**  
*Conventional  
Driveway Slows  
Turning Vehicles*

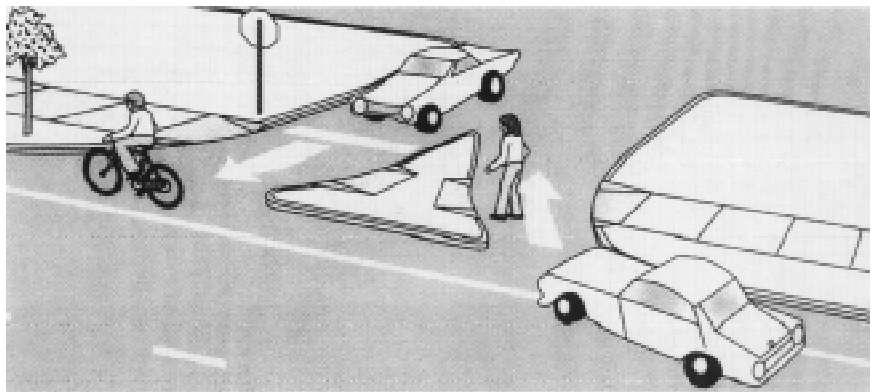
Source: Oregon Department of  
Transportation, *Oregon Bicycle  
and Pedestrian Plan*.



---

**Figure 3.8**  
*Intersection-Style  
Driveway May  
Encourage High-  
Speed Turns*

Source: Oregon Department of  
Transportation, *Oregon Bicycle  
and Pedestrian Plan*.



---

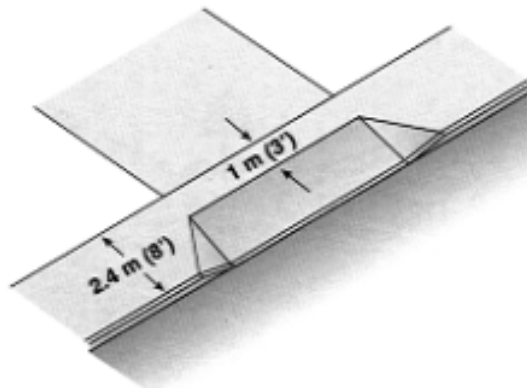
## Facilitating Wheelchair Movement at Driveways

To facilitate wheelchair movement at driveways, the following techniques prevent an exaggerated warp and cross-slope.

- ◆ Reducing the number of accesses reduces the need for special provisions. This strategy should be pursued first.
- ◆ Constructing wide sidewalks avoids excessively steep driveway slopes. The overall width must be sufficient to avoid an abrupt driveway slope (see figure 3.9).
- ◆ Planting strips allow sidewalks to remain level, with the driveway grade change occurring in the planting strip (see figure 3.10).
- ◆ Where constraints don't allow a planting strip, wrapping the sidewalk around driveway entrances has a similar effect, although this method may have disadvantages for the vision-impaired who follow the curb line for guidance (see figure 3.11).
- ◆ When constraints allow for only minimal sidewalks behind the curb, dipping the entire sidewalk at approaches keeps the cross-slope at a constant grade (see figure 3.12). This may be uncomfortable for pedestrians and may create drainage problems behind the sidewalk.

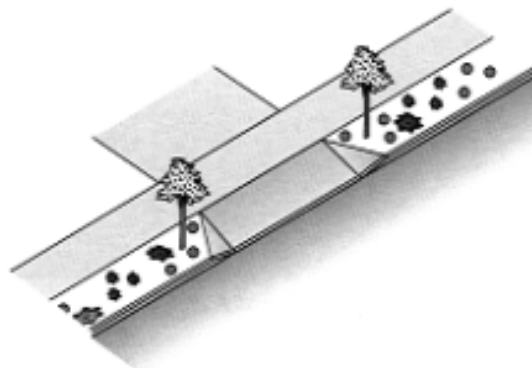
---

**Figure 3.9**  
*Wide Sidewalk at Driveway*

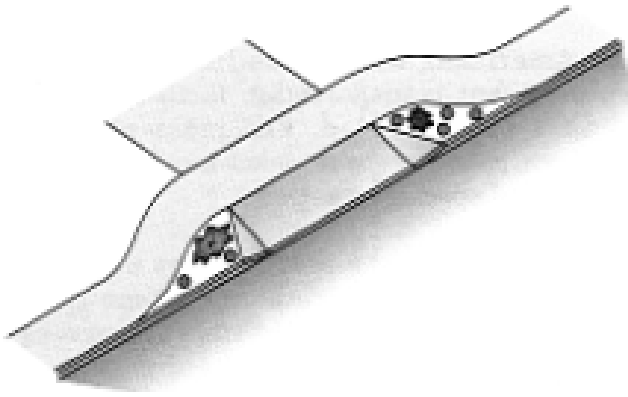


---

**Figure 3.10**  
*Driveway with Planting Strip*

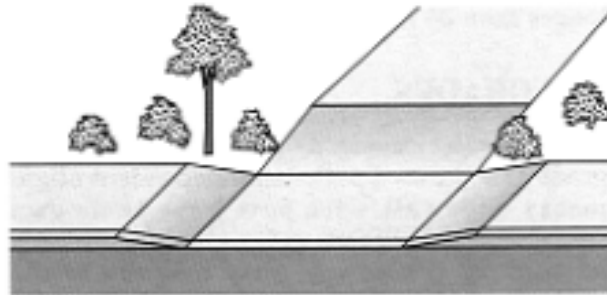


**Figure 3.11**  
*Sidewalk Wrapped Around Driveway*



**Figure 3.12**  
*Entire Sidewalk Dips at Driveway*

Source: Oregon Department of Transportation, *Oregon Bicycle and Pedestrian Plan*.



#### ACCESS MANAGEMENT

Most pedestrian/motor vehicle collisions on busy streets occur at points of intersection movements, such as intersections, driveways, and alleys. Unlimited vehicle access on roads increases the level of conflicts between pedestrians walking along the roadway and cars entering or leaving the roadway. Think about it: we strictly limit/control pedestrian crossings but tend to accept and accommodate almost universal motor vehicle access (e.g., continuous two-way left-turn lanes).

Pedestrians crossing the roadway need gaps in the traffic stream, but with unlimited access, vehicles entering the roadway quickly fill the available gaps. Pedestrian access to transit may also be complicated by excessive driveway access points creating obstacles on the way to the bus stop.

The following list describes access management techniques as well as several benefits for pedestrians that result from access management. Figure 3.13 illustrates how controlled access and limited driveways reduce conflict points between pedestrians and motor vehicles.

#### TECHNIQUES

- ◆ Reducing the number of existing driveways or consolidating driveways to parking areas and businesses.
- ◆ Providing raised or landscaped medians or concrete barriers to control turning movements from the street (with these treatments, it is

#### Access Management



important to provide accessible pedestrian crossing opportunities with breaks in the medians or barriers at suitable crossing points).

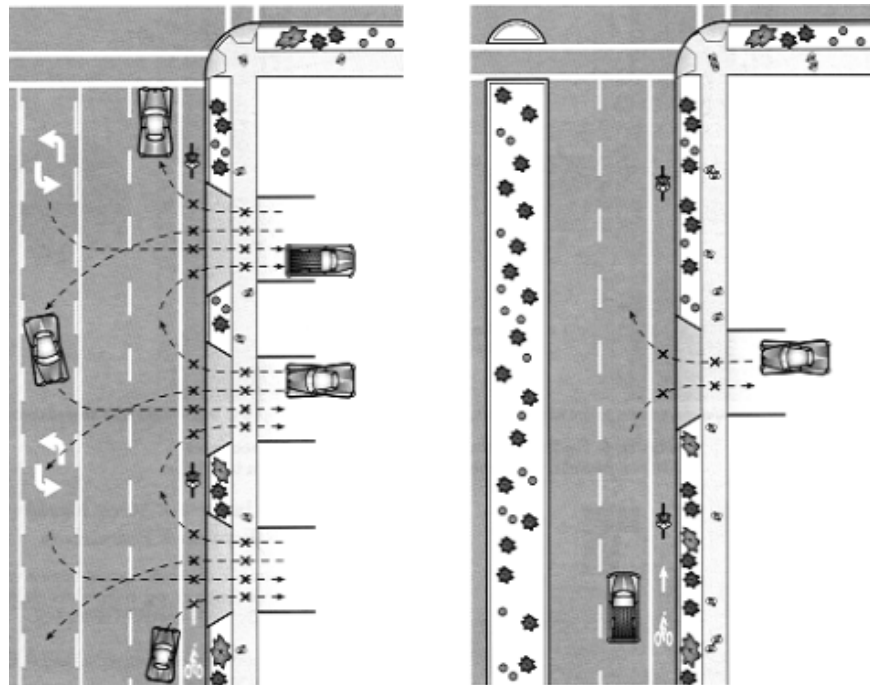
**BENEFITS**

- ◆ The number of conflict points is reduced (particularly with the use of center medians to reduce the number of conflicts between left-turning vehicles and pedestrians).
- ◆ Pedestrians crossing opportunities are enhanced with an accessible raised median and fewer conflicts with turning cars.
- ◆ Accommodating people with disabilities becomes easier with the reduced need for special treatments at driveway cuts.
- ◆ Traffic volumes may decrease if local traffic can use other available routes.
- ◆ Improved traffic flow may reduce the need for road-widening, allowing more space within the right-of-way for use by pedestrians, bicyclists, and enhancements and maintaining fewer travel lanes to cross at intersections (see figure 3.13).

Source: Oregon DOT, *Bicycle and Pedestrian Plan*, 1996.

**Figure 3.13**  
*Reducing Conflict  
Using Access  
Management*

Source: Washington Department  
of Transportation, *Pedestrian  
Facility Guidebook*.



Uncontrolled accesses create 8 potential conflict points at every driveway.

A raised median and consolidating driveways reduce conflict points.



## 3.5 INTERSECTIONS AND CROSSINGS

The needs of pedestrians deserve equal consideration with the needs of motorists and other intersection users. Pedestrians have historically been treated as an afterthought in design of transportation facilities, but current practices encourage design approaches that improve conditions for pedestrians and fully integrate them into the transportation system.

These design approaches need to define ways to protect the access and safety of pedestrians, the most vulnerable user group at intersections, while still adequately meeting the needs of motor vehicles.

---

### Basic Principles of Intersection Design to Accommodate Pedestrians

- ◆ Intersections that function well for pedestrians are typically compact.
- ◆ Free-flowing motor vehicle movements are either eliminated or vehicles are forced to a significantly slower speed through the intersection.
- ◆ All legs of an intersection should be available for pedestrian use; closing a crosswalk doesn't necessarily prevent pedestrians from crossing in that direction.
- ◆ Pedestrians need to be able to travel in a direct line across the intersection leg and the direction of travel needs to be clearly identified for all pedestrians, including those with sight impairments.
- ◆ Avoid increasing potential conflicts or the level of pedestrian exposure to motor vehicles.

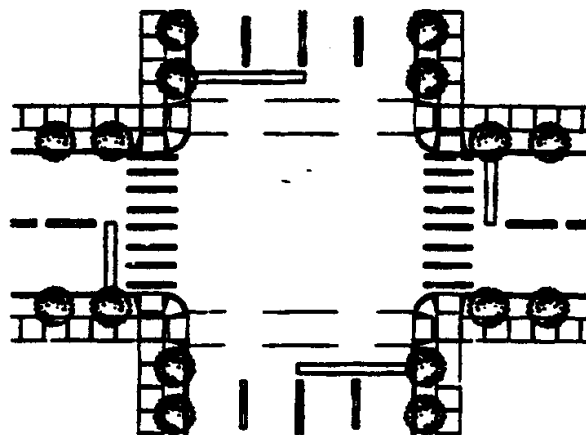
Source: Washington Department of Transportation, *Pedestrian Facilities Guidebook*.

### CROSSWALKS

Crosswalks are, perhaps, the most critical element in the pedestrian network. While most people can find a way to travel along the street, it

**Figure 3.14**  
*Marked and  
Unmarked  
Crosswalks at  
Intersection*

Source: Washington Department  
of Transportation, *Pedestrian  
Facility Guidebook*.



is a fact that most crashes involving pedestrians take place when they are trying to cross the street. Safe crossings, including crosswalks, are essential.

A crosswalk is generally defined as the portion of the roadway designated for pedestrians to use in crossing the street. Marked crosswalks increase visibility of the pedestrian crossing area, define the space for crossing, and draw pedestrians to the appropriate crossing point. There is no legal difference between a marked or unmarked intersection crossing (see figure 3.14). Unmarked crosswalks exist where a sidewalk or walkway, if extended beyond the curb in the direction it is heading, would cross a street or highway.

There are several attributes of good crosswalks that can help lead to good design decisions.

---

## Attributes of Good Crosswalks

**Clarity.** It should be obvious where to cross and easy to understand possible conflict points with traffic.

**Visibility.** The location and illumination of the crosswalk should allow pedestrians to see and be seen by approaching traffic while crossing.

**Appropriate intervals.** There should be a reasonable match between the frequency of good crossing opportunities along a street and the potential demand for crossing.

**Short wait.** A pedestrian should not have to wait unreasonably long for an opportunity to cross.

**Adequate crossing time.** The time available for crossing should accommodate users of all abilities.

**Limited exposure.** Conflict points with traffic should be few and the distance to cross should be short, or it should be divided into shorter segments with refuges.

**Continuous path.** The crosswalk should be a direct continuation of the pedestrian's travel path.

**Clear Crossing.** The crosswalk should be free of barriers, obstacles and hazards.

Source: Adapted from City of Portland, Office of Transportation,  
*Pedestrian Design Guide.*

### *Location*

Marked crosswalks are generally located at all open legs of signalized intersections. They may also be considered at other locations. Combined with curb extensions, illumination, and signage, marked crosswalks can improve the visibility of pedestrian crossings. Crosswalks help send the message to motorists that they are encroaching on a



pedestrian area, rather than the reverse—that pedestrians are cluttering the roadway, which is too often the common reaction.

It is recommended that the following guidelines for installing pedestrian crossing improvements (including marked crosswalks) be used to help identify other sites where crossings should be considered.

---

## Recommended Sites for Crosswalks

- ◆ Part of a school walking route.
- ◆ Part of a route identified in a nonmotorized transportation or pedestrian circulation plan.
- ◆ Where there is a connection to significant retail activity.
- ◆ Where there is an important transit connection.
- ◆ Where the distance to a better crossing point is more than 300 feet.
- ◆ Where a majority of the people served by the crossing have a more difficult that average time crossing the street.
- ◆ Where a safety problem can be addressed by improving the crosswalk.

Source: KPG, Inc., for the City of Kirkland Transportation Department, *Pedestrian Improvements Demonstration Project* (Kirkland, WA, 1996).

The ITE states that for marked crosswalks to be continually effective, they must be located and designed in accordance with good judgment and accepted engineering practices.<sup>25</sup> The Manual on Uniform Traffic Control Devices (MUTCD) contains the following provisions related to crosswalks.

---

## FHWA Provisions Relating to Crosswalks

### *Shall*

- ◆ Have 6-inch minimum width markings consisting of solid white lines.

### *Should*

- ◆ Have 6-foot minimum crosswalk width.
- ◆ Be used where substantial pedestrian and vehicle conflicts exist.
- ◆ Be used at appropriate points of pedestrian concentration or where the pedestrian could not otherwise recognize the proper place to cross.
- ◆ Not be used indiscriminately.
- ◆ Be installed based on an engineering study if location is other than at a STOP sign or traffic signal.
- ◆ Have advance warning signs if installed mid-block where pedestrians are not expected, and allow for restriction of parking for adequate visibility.

<sup>25</sup> ITE



### *May*

- ◆ Be marked with white diagonal or longitudinal lines (parallel to vehicle traffic for added visibility).
- ◆ Omit the transverse crosswalk lines when the extra markings are added.
- ◆ Use unique markings for diagonal crossings at signals when an appropriate exclusive pedestrian phase is used.

Source: FHWA, *Manual on Uniform Traffic Control Devices*, 1988.

The following design guidelines for crosswalks are recommended for the Kansas City region:

---

## Recommendations for Crosswalks

- ◆ An 8-foot crosswalk is the recommended standard width (6-foot minimum), while wider crosswalks may be used where higher pedestrian volumes exist or where it is desirable to increase the conspicuity of the crosswalk. Because of the high costs associated with crosswalk installation and operational concerns with narrow crosswalks, it is beneficial to install wider crosswalks and more crosswalk marking materials than the minimum MUTCD requirements.
- ◆ Crosswalk lines of 10-12 inches in width are recommended with wider lines (18-24 inches) used when greater emphasis is considered helpful. At intersections it is desirable that the line of the intersection side be offset at least 2 feet from the edge of the roadway.
- ◆ The placement of crosswalk markings should take the curb ramp location into consideration and be placed such that wheelchair pedestrians can access the ramps without leaving the crosswalk.

Source: Based on ITE guidelines, *Design and Safety of Pedestrian Facilities*.

### *Markings*

Crosswalks can be marked using various methods (see figure 3.15). Crosswalk marking patterns vary and limited information is available about the relative effectiveness of different designs. Generally, high visibility markings are suggested for locations where greater motorist information is considered beneficial and where pedestrians may not be expected to cross (such as mid-block locations), or where there are substantially higher pedestrian crossing volumes.

Horizontal bars (two stripes perpendicular to vehicle traffic) are most often used at stop-controlled intersections.

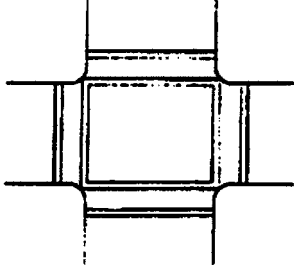
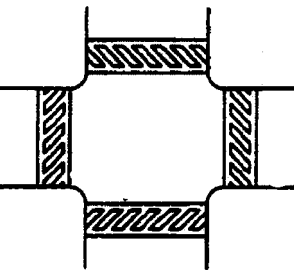
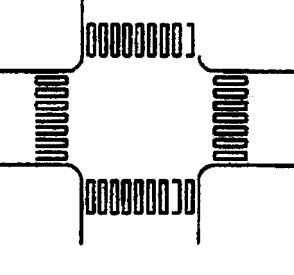
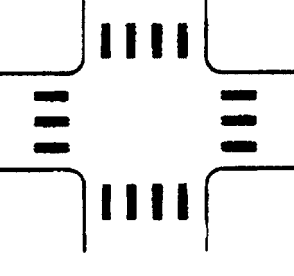
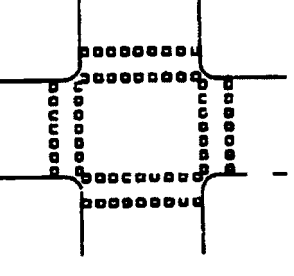
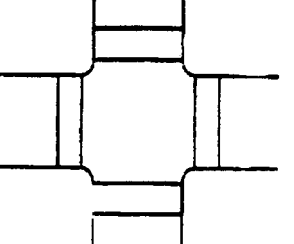
Diagonal markings or “zebra” stripes are more visible than horizontal bars, but diagonal markings tend to require replacement more often since they are subject to more friction from the wheels of motor vehicles. Piano bar markings are being used more frequently because they provide the benefit of good visibility and easier maintenance. With the piano bar





**Figure 3.15**  
*Advantages and Disadvantages of Crosswalk Marking Patterns*

Source: Washington DOT, *Pedestrian Facilities Guidebook*.

	MARKING PATTERNS	ADVANTAGES	DISADVANTAGES
	HORIZONTAL BARS	Common practice at stop-controlled intersections, less expensive, easy to install and maintain.	Not as visible as some other marking types; bars tend to wear faster than other types; not appropriate for mid-block locations.
	ZEBRA	Highly visible.	More maintenance required since wheel friction rubs off diagonal stripes; surface can be slippery.
	LADDER BAR	Highly visible.	Wider stripes rub off with wheel friction, but can be placed to minimize this effect; surface can be slippery.
	PIANO	Highly visible and becoming more commonly used; easy to maintain since stripes can be placed outside the wheel friction areas.	
	DASHED <i>(European)</i>	Captures attention because it is not a commonly used pattern.	May not define space as well as some other choices.
	SOLID	Visible (but may not be as eye-catching as other patterns); not commonly used.	Expensive; more difficult to install and maintain; surface can become slippery.



pattern (and the ladder bar), the wheels of motor vehicles typically pass on either side of the markings, minimizing friction and deterioration.

## MEDIANS AND REFUGE ISLANDS

Medians and center refuge islands at intersections and mid-block locations provide a waiting area for pedestrians and eliminate the need for pedestrians to cross both directions of traffic all at once. Medians and center refuge islands can be created at intersections or mid-block to help define the pedestrian walking space and provide protection and refuge from motor vehicles.

This is particularly important on wide, higher speed roadways. Pedestrians trying to cross an undivided, multilane street may experience delays ten times longer than the delay incurred crossing a street with a median.<sup>26</sup> The effect of refuge islands and medians on pedestrian safety has been studied in the United States and abroad in recent years. A 1993 study found that streets with raised medians, in both central business districts and suburban areas, have lower pedestrian crash rates compared to streets with a painted two-way left-turn lane or undivided streets.<sup>27</sup>

### *Location*

Refuge islands are typically shorter than medians, but either can be used at intersections. Medians and center refuge islands provide the benefit of turning one two-way street into two one-way streets from the perspective of the pedestrian. Pedestrians only have to cross one direction of traffic at a time and can wait and rest in between if necessary. Medians and refuge islands are generally most necessary where the length of crossing exceeds 60 feet, depending on the signal timing, but can be used at intersections with shorter crossing distances where a need has been determined. (See the next section, Mid-Block Crossings, for a detailed discussion of using medians at mid-block locations.)

---

### Recommended Sites for Medians and Refuge Islands

- ◆ Wide, two-way streets with high traffic volumes, high travel speeds, and large pedestrian volumes.
- ◆ Wide streets where children, people with disabilities, or elderly people cross regularly.
- ◆ Wide two-way intersections with complex vehicle movements and/or long signal phase cycles.
- ◆ Low volume side street traffic demands with insufficient time to cross.

<sup>26</sup>Transportation Research Board (TRB), *Planning and Implementing Pedestrian Facilities in Suburban and Developing Rural Areas, National Cooperative Highway Research Program Report 294A*. (Washington, DC, 1987).

<sup>27</sup>Bowman, B.L and R. L. Vecellio, *Investigation of the Impact of Medians on Road Users, Final Report No. FHWA-RD-93-130* (Washington, DC, 1993).

<sup>28</sup>Based on ITE, *Design and Safety of Pedestrian Facilities*



---

## Design Considerations for Medians and Refuge Islands

### Design

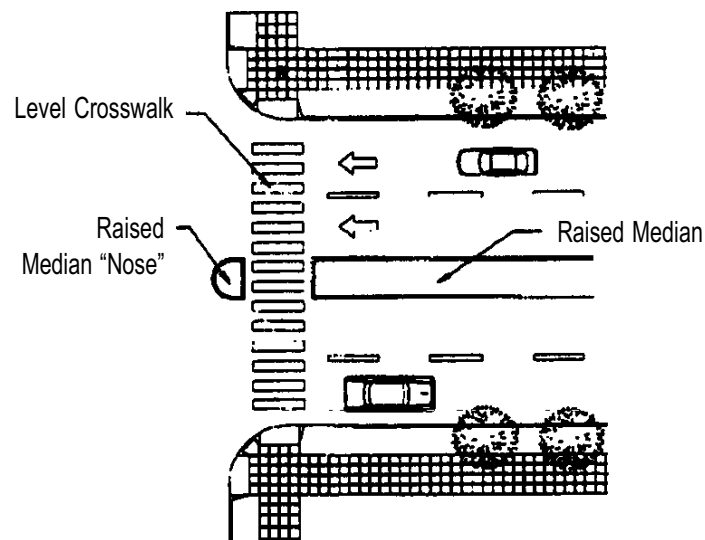
The ITE states that pedestrian refuge islands must be designed in accordance with the AASHTO policy and the MUTCD requirements.<sup>28</sup> The design considerations listed by ITE include the following:

- ◆ Areas at traffic signals where the total length of crosswalk cannot be readily traveled in one pedestrian phase. Special consideration should be given to intersections where elderly pedestrians and/or people with disabilities will be present. Special consideration also should be given to complex or irregularly shaped intersections where islands could provide a pedestrian with the opportunity to rest and become oriented to the flow of oncoming traffic.
- ◆ Raised curbs with cut-through ramps at pavement level or curb ramps for wheelchair users. Cut-through ramps should be graded to drain quickly and should also have special provisions to assist the visually impaired in identifying the refuge island. Islands with ramps should have a level area at least 48 inches long at the same level as the top of the raised median to provide a level area for wheelchair users.
- ◆ Street-level cut-through areas should be at least 6 feet wide from face-of-curb to face-of-curb, to accommodate movement by persons in wheelchairs. The minimum width should not be less than 4 feet wide face-of-curb to face-of-curb.
- ◆ The island should not be less than 12 feet long or the width of the crosswalk, whichever is greater. The minimum island size should be 50 square feet.
- ◆ An approach “nose,” offset from the edge of the traffic lane (see figure 3.16), appropriately treated to provide motorists with sufficient warning of the island’s presence. This can be achieved through various considerations such as illumination, reflectorization, marking, signing, and/or size.

---

**Figure 3.16**  
*Intersection Median/Refuge*

Source: Washington Department of Transportation, *Pedestrian Facility Guidebook*.



---

## Recommendations for Medians and Refuge Islands

- ◆ Pedestrian push buttons and signing adjacent to crosswalks.
- ◆ Guidestrips or other warnings for the blind.
- ◆ No obstructions to visibility by such features as foliage, barriers, or benches.

The following design guidelines for medians and refuge islands are recommended for the Kansas City region:

- ◆ Medians and refuge islands should be a desirable width of 8-10 ft wide and a minimum width of 6 ft wide to prevent wheelchairs propelled by attendants, bicyclists, and people with strollers from projecting out into the stream of motor vehicle traffic. In some cases, smaller width medians and refuge islands may be acceptable, particularly where there is limited space in the right-of-way, depending on existing conditions.
- ◆ In order to obtain appropriate median width, travel lanes can be narrowed to 11 ft, if allowed by local standards. In locations where vehicle speeds range from 20-30 mph, the travel lanes can be reduced further to 10 or 9 ft, if allowed by local standards. Note: *this has the added positive effect of further slowing motor vehicle speeds at the crossing location.*
- ◆ Trees in medians and at the sides of streets can help to narrow the long range field of vision for approaching drivers, causing them to slow down as they near the crossing point. Landscaping in median refuge islands must be handled carefully. It is essential that landscaping not block the sight lines of pedestrians and motorists at the crossing area.
- ◆ Curb ramps or full cut-throughs should be installed in all median refuge islands. Cut-throughs are more common because the median width is sometimes not large enough to accommodate ramps that meet the ADA requirements. Cut-throughs should be designed with a 2 percent cross slope to allow water, silt, and debris to drain from the area.
- ◆ A pedestrian push button should be placed in the median of signalized mid-block crossings where the crossing distance exceeds 60 ft.
- ◆ Medians and refuge islands should be illuminated.

Source: Based on ITE, *Design and Safety of Pedestrian Facilities*.

### MID-BLOCK CROSSINGS

In some urban areas where distances between intersections are long, mid-block crossing points can provide pedestrians opportunities to cross safely. Mid-block crossings can also provide convenience and safety in less developed areas where pedestrian activity is high (such as between a school and a residential area; housing and a grocery store; or a bus stop and a shopping center). While some traffic engineers resist considering



mid-block crossings, the reality is that most pedestrians will not go far out of their way to cross a street, especially children. It makes more sense to provide a good crossing than to pretend there isn't a need.

### ***Location***

Locations being considered for a mid-block crossing need to be carefully studied. The following guidance for determining locations for mid-block crossing installation is based on the ITE report on pedestrian facilities.

---

## Recommended Sites for Mid-Block Crossings

- ◆ Where significant pedestrian crossings and substantial pedestrian/vehicle conflicts exist.
- ◆ Where the crossing can serve to concentrate or channelize multiple pedestrian crossings to a single location.
- ◆ At approved school crossings or crossings on recommended safe school walk routes.
- ◆ Where land uses create high concentrations of pedestrians wanting to cross, such as residential areas across from retail or recreation, and transit stops across from residential areas or employment.
- ◆ Where there is a need to delineate the optimal location to cross.
- ◆ Where there is adequate sight distance for the motorist and pedestrian. Any obstacles that would interfere with visibility at the crossing location (mailboxes, utility poles, street furniture, signs, and landscaping) should be removed or relocated. On-street parking should be set back from the crossing point for improved visibility.
- ◆ If located at other than an existing stop sign or traffic signal, should be installed on the basis of an engineering study with active public involvement.

Source: Based on ITE, *Design and Safety of Pedestrian Facilities*.

Mid-block crossings should generally be avoided under the following circumstances (unless they are stop-controlled):

- Immediately downstream (less than 300 feet) from a traffic signal or bus stop where motorists are not expecting pedestrians to cross.
- Within 300 feet of another crossing point, except in central business districts or other locations where there is a well-defined need.
- On high speed streets with speed limits above 45 mph.

### ***Design***

Crossing design treatments are often used in combination with one another at mid-block crossings. Standard practices as well as some more innovative techniques are being tested around the country. Determining methods of crossing design treatments and related traffic control requires



careful consideration and traffic engineering analysis of existing conditions on a project-by-project basis.

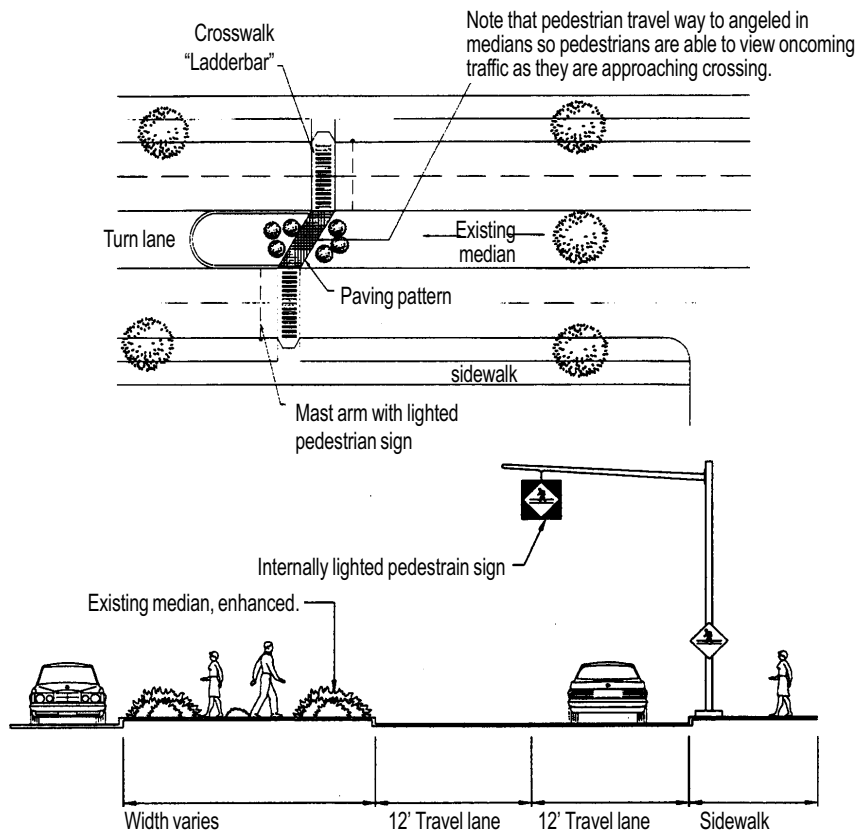
**Marked Crosswalks.** Mid-block crossings should always be marked with highly visible crosswalks, otherwise pedestrians and motorists may have trouble recognizing the designated crossing point. Various crosswalk designs are discussed in an earlier section. The use of zebra, ladder, or piano bar markings are highly recommended over the use of other types of crosswalk markings because of their high visibility. Horizontal bars are not typically used at locations other than controlled intersections. Crosswalk markings should be at 90 degrees to the street to designate the shortest path for crossing and minimize pedestrian exposure. In refuge islands and medians, angling the crossing provides an opportunity for pedestrians to view oncoming traffic (see figure 3.17).

Stop bars should be placed in advance of crosswalks. They are usually 12-24 inches wide, solid white lines that extend across all approaching lanes. They are usually installed at a minimum of 4 feet in advance of the crosswalk to prevent motorists from encroaching into the pedestrian crossing space.

**Mid-Block Pedestrian-Actuated Signals.** The MUTCD bases the need for pedestrian crossing traffic control on the number of adequate gaps or space between the vehicles in the roadway's traffic stream. It states that pedestrians must wait for a gap in traffic that is of sufficient duration to permit street crossings without interference from vehicular traffic.

**Figure 3.17**  
*Mid-Block Crossing  
of Arterial Street*

Source: Washington Department  
of Transportation, *Pedestrian  
Facility Guidebook*.



When adequate gaps occur less frequently than an average of once per minute, some form of traffic control is necessary.

Pedestrian-actuated signals are often appropriate for roadways that have high traffic volumes or speeds, or four or more lanes. Since these signals only operate in the presence of foot traffic, they do not cause undue delay to vehicles during periods of low pedestrian volumes. Pedestrian-actuated signals should be considered in locations where pedestrian walk routes cross major arterials or other high-volume or high-speed facilities.

**Medians and Mid-Block Refuge Islands.** Medians and mid-block refuge islands are raised longitudinal spaces separating the two main directions of travel movement in the street (see previous section). Refuge islands are shorter than medians, typically up to 20 feet long. Refuge islands are more commonly used at mid-block crossings than medians, but either provides major benefits for pedestrians and motorists.

Medians and refuge islands reduce crossing distances for pedestrians and effectively turn one two-way street into two one-way streets for pedestrians. Pedestrians only have to cross one direction of traffic at a time and can wait or rest in between. This creates a better opportunity for pedestrians to find gaps in the flow of traffic before crossing the street. Medians and refuge islands are a benefit to drivers when located at mid-block crossings, because they help to better identify the upcoming crossing point. They also provide a location for a pedestrian crossing sign in the middle of the street, providing another opportunity to warn drivers of the crossing.

Medians and refuge islands are recommended whenever mid-block crossing distances exceed 60 feet to provide a waiting and resting area for slower pedestrians. Refuge islands can be installed with more flexibility in a variety of locations because they are shorter. Refuge islands are easily located on low-volume, low-speed roadways, such as 25 to 30 mph collectors or subcollectors through neighborhoods. When collectors are longer and handle more traffic and higher speeds, medians or refuge islands are helpful. On multi-lane minor and major arterials, raised medians or refuge islands are essential.

**Raised Mid-Block Crossings.** Raised mid-block crossings are sometimes constructed to provide a well-defined pedestrian crossing as well as traffic calming. This type of crossing is only suitable for low-speed, low-volume local streets, since the raised crossing is essentially functioning as a speed table or hump.

Raised crossings enhance pedestrian safety by creating a vertical pavement undulation that forces motorists to slow down when approaching. Raised crossings function as an extension of the sidewalk and allow pedestrians to cross at a constant grade, without the need for curb ramps or median cut-throughs. Raised crossings should have a 6-foot parabolic approach transition, raising the vehicle 3 to 4 inches above the nominal



pavement grade. The flat section of the crossing table should be 10 to 12 feet wide.

Raised crossings need to be highly visible, either striped as a mid-block crossing or constructed of a contrasting pavement design. Raised crossings should be signed with advance warning signs and pedestrian crossing signs in the same manner as other mid-block crossings.

**Flashing Beacons.** A crosswalk with a flashing beacon provides a relatively low-cost treatment for mid-block pedestrian crossings. These devices are authorized by the MUTCD under the sections related to hazard identification beacons. The flashing light alerts drivers in advance of potential pedestrians without forcing them to stop, unless there is actually a pedestrian in the crosswalk. This sort of device can be used on roadways with higher vehicular volumes without causing undue delay to drivers.

Flashing beacons are most effective if they are operating only during times when there is a clear need to alert the motorist, such as when pedestrians are actually present (rather than constantly flashing).

**Advance Warning Signs and Pedestrian Crossing Signs.** Advance Pedestrian Crossing signs should always be installed in advance of mid-block crossings (MUTCD Sign W11-2; see figure 3.18). Placement of advance warning signs depends on the speed of motor vehicle traffic and other conditions, such as available sight distance. Refer to the MUTCD for sign placement criteria.

The Pedestrian Crossing sign (MUTCD Sign W11A-2; see figure 3.18) is similar to the Advance Pedestrian Crossing sign, but has the crosswalk lines shown on it. This sign should be used only at the crosswalk location and not in advance of it. This sign is now commonly being

**Figure 3.18**  
*Pedestrian Crossing Signs (MUTCD)*

Source: FHWA, *Manual on Uniform Traffic Control Devices*.



*Single section with cut-out letters.*



*Two-section type.*

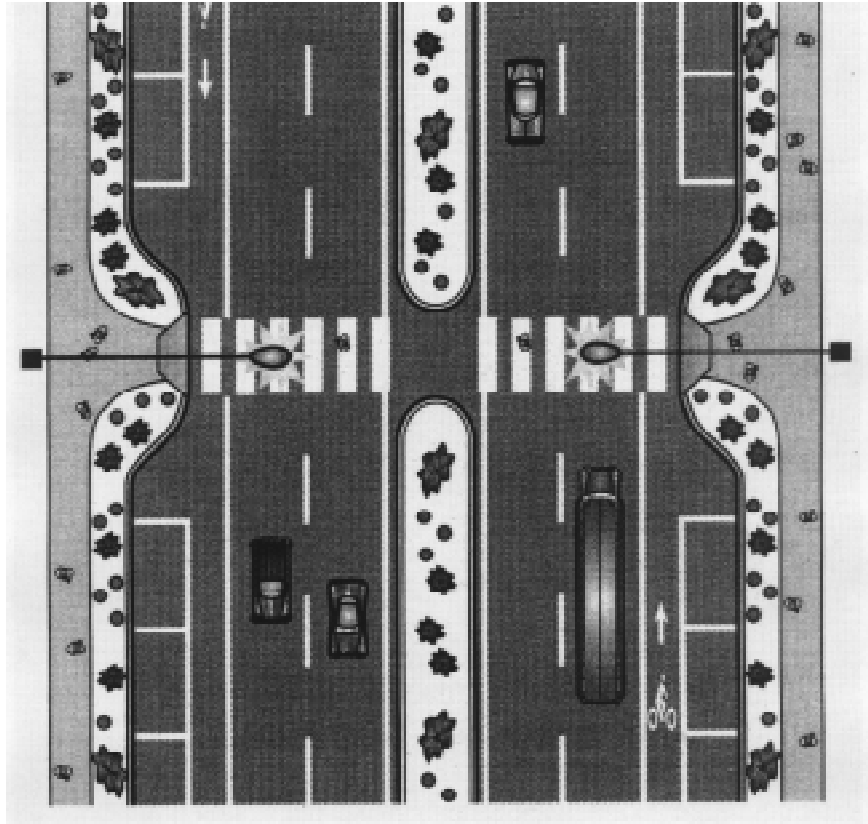




placed overhead on a steel pole and mast arm. In some situations the sign is equipped with internal lighting for increased visibility at night. Pending changes to the MUTCD allow for the use of fluorescent yellow/green coloring for these signs.

**Figure 3.19**  
*Lighting of  
Mid-Block  
Crossings*

Source: Oregon Department of Transportation, *Oregon Bicycle and Pedestrian Plan*.



**Other Design Considerations.** It is usually necessary to supplement the existing street lighting system with additional lighting at new mid-block crossing locations (see figure 3.19). It is extremely important that these crossing locations be well-illuminated, so they are clearly visible to motorists driving at night.

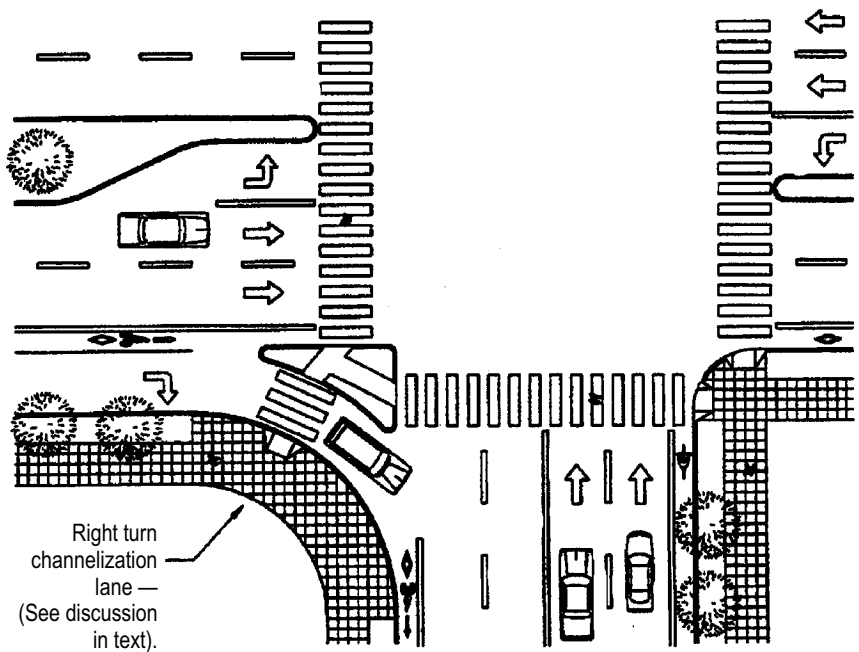
#### **SLIP LANES**

Slip lanes, or right-turn channelization lanes with refuge islands, as they are also known, are not a pedestrian's best friend. They are provided to allow right-turning motor vehicles to proceed without stopping and, generally, at a higher speed than if they had to make a 90-degree right turn. At wide intersections with such a slip lane, there is often a triangular space between the through-lane and the right-turn (slip) lane that is unused by motorists. Placing a raised island in this area provides pedestrians a refuge area when crossing(see figure 3.20). This may be an appropriate solution when curb return radii of larger than 30 feet are unavoidable. However, slip lanes are not recommended in areas of high pedestrian use.



**Figure 3.20**  
*Right-Turn Lane and  
 Pedestrian Refuge*

Source: Washington Department  
 of Transportation, *Pedestrian  
 Facility Guidebook*.



Where slips lanes are used and a refuge island is provided, it should be raised to provide a vertical barrier and added protection between vehicles and pedestrians. Refuge islands need to provide curb ramps, or cut-throughs (preferred), for accessible passage.<sup>29</sup> Pedestrian push buttons may be needed when the signal timing doesn't allow all pedestrians to cross the street on one crossing phase.

**GRADE SEPARATED  
 CROSSINGS**

There are some very divergent views on the idea of using grade-separated crossings for pedestrians. Consider the following two statements: "Grade-separated crossings refer to facilities that provide for pedestrians and motor vehicles to cross at different levels, and such facilities can greatly reduce pedestrian-vehicle conflicts and potential accidents. Not only have grade-separated structures been found to substantially improve pedestrian safety, they can also reduce vehicle delay, increase highway capacity, and reduce vehicle accidents when appropriately located and designed."<sup>30</sup>

*"Because pedestrians tend to cross where it is most convenient, grade-separated crossings are rarely successful where there is any possibility of gaps in the traffic stream that are adequate for crossing at grade. Use grade-separated crossings only where it is not possible to provide an at-grade facility. Examples include crossing a freeway or major highway, a rail yard, or a water way."<sup>31</sup>*

<sup>29</sup> See AASHTO, *A Policy on Geometric Design*, for design details.

<sup>30</sup> From ITE, *Guidelines for Pedestrian Facilities*.

<sup>31</sup> From City of Portland, *Pedestrian Design Guide*



While the traffic engineers like the idea of reducing vehicle delay and increasing highway capacity, the more pedestrian-oriented view rejects any grade separations except for those that are absolutely necessary. This is readily explained: pedestrians do not want to be inconvenienced by added time, distance, and effort, and grade-separated crossings-when there is any opportunity to cross at grade-impose all of these “penalties.” Most pedestrians will tend not to use a grade-separated crossing if there is any way to cross at grade. Therefore, at-grade crossings are always preferred and grade-separated crossings should only be considered where there is not a feasible alternative.

Another aspect of the at-grade vs. grade-separated issue relates to skywalks. Skywalks are pedestrian facilities used to connect buildings and can function successfully, especially in areas where inclement weather is common. However, some communities have experienced a loss of pedestrian activity at street level, negatively impacting the retail businesses and economic vitality of the area. Further, skywalks are not an acceptable substitute for a pedestrian-friendly, at-grade infrastructure. Several types of grade-separated crossings have been used, including:

**Pedestrian Overpasses/Bridges.** These are passageways for pedestrians constructed over a roadway in which stairs or ramps generally lead up to the overpass. ADA requires that stairs should not be the only means to access an overpass or underpass, although they can be used with a ramp.

**Elevated Walkways.** These refer to sidewalks and walkways above ground level that often run parallel to the flow of motor vehicles. Such facilities may be freestanding or connected to adjacent buildings.

**Pedestrian Tunnels/Underpasses.** These generally involve stairs or ramps that lead down to a below-ground passageway. In some cases, however, the underpass is at ground level and the road is elevated. Typically, tunnels and underpasses are less expensive to install than overpasses. It is essential that such facilities be well-lit to address the security concerns of pedestrians.

## SIGNALIZATION

According to the ITE, traffic signals are intended to assign the right-of-way to vehicular and pedestrian traffic.<sup>32</sup> Given that most traffic engineers view as their primary objective the reduction in vehicle delay, it is easy to understand why they have been-and generally continue to be-reluctant to implement various actions designed to improve conditions for walking: pedestrians in the street delay motor vehicles. And, this inherent conflict-accommodating pedestrian crossings vs. reducing vehicle delay-manifests itself most overtly in the use of traffic signals. It is rare to find signals designed to promote and enhance walking by giving priority to pedestrians. The ITE confirms this in its discussion of the MUTCD warrants for installing new traffic signals: “Studies have

<sup>32</sup> ITE, (page 43)



found that only a small percentage of new traffic signals have been installed in the United States based primarily on pedestrian considerations.”<sup>33</sup>

Unfortunately, much of the application and operation of traffic signals is codified in the MUTCD. Until there can be serious and significant changes made to the MUTCD, attention should be given to adjusting signal timing to better serve pedestrians. The walking speed normally used for calculating pedestrian walking time is 4 feet per second, but this may not provide adequate crossing time for all pedestrians. The MUTCD recommends at least a 4- to 7-second walk interval, but the ITE raises some real concerns:

*“However, at some intersections, this may present a dilemma to pedestrians who see a DON’T WALK display before they are more than one or two lanes across the street. In actual practice the pedestrian almost always continues forward rather than return to his or her starting point. It would be very desirable to provide a longer WALK interval at some locations if possible.*

*“The fifteenth percentile walking speed should be used for setting the design walk speed where there is a high proportion of elderly pedestrians. In the absence of a specific study this would be between 3 and 4 feet per second, depending on the presence of slower pedestrians.”<sup>34</sup>*

Another aspect of traffic signals and pedestrians that deserves greater attention is the location and use of pedestrian push buttons for pedestrian-actuated signals. In general, where WALK/DON’T WALK signals are used, pedestrians should automatically get a WALK interval with every cycle of the lights, just as motorists get a green light each time. Push buttons are needed at intersections where the traffic signal is demand-actuated by motor vehicles so that a pedestrian can actuate the signal in the absence of a motor vehicle.

Pedestrian push buttons should be mounted 3 1/2 to 4 feet above the sidewalk and placed in a conspicuous, convenient location, preferably next to, but not obstructing, the curb ramp. To the extent possible, pushbutton location should be standardized, to provide a more predictable walking environment for persons with low vision and the blind. To supplement lighted pedestrian signals, audible signaling may be used to cue pedestrians and provide directional guidance to the blind (particularly at non-perpendicular intersections.)<sup>35</sup>

<sup>33</sup> Ibid., (page 44)

<sup>34</sup> ITE, (page 46)

<sup>35</sup> Access Board, Accessible Pedestrian Signals (Washington, DC, 1998)



### 3.6 SIDEWALK MANAGEMENT AND MAINTENANCE

While simply providing a sidewalk is a major step towards making it easier and safer for people to walk, the management of sidewalk conditions—including the management of public sidewalk space, lighting, landscaping and trees, and maintenance—is critical to determining how well sidewalks serve their intended purpose.

#### Defining Streetside Space

Several recent guides to pedestrian facility planning and design have described a system for dividing up “streetside” space, that is the space between the edge of the roadway and the right-of-way line (see figure 3.21).<sup>36</sup>

The following terminology is recommended for the metropolitan Kansas City area:

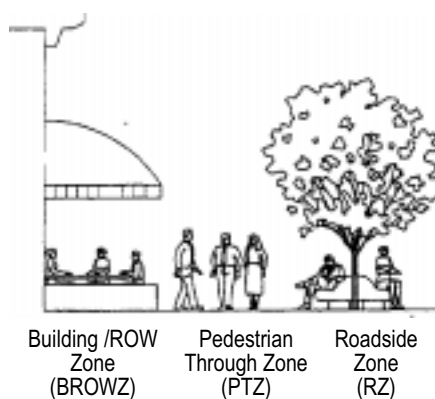
**Roadside Zone (RZ).** Also known as the “furnishings zone” or “fixture/planting zone,” the roadside zone buffers pedestrians from the adjacent road and is also the area where elements such as street trees, signal poles, utility poles, streetlights, parking meters, and other items are properly located. This is the area where people enter and exit parked cars.

**Pedestrian Through Zone (PTZ).** Also known as the “pedestrian travel zone” or “through pedestrian zone,” the pedestrian through zone is the area where most pedestrians travel and it should be maintained entirely free of permanent and temporary objects.

**Building/ROW Zone (BROWZ).** Also known as the “building frontage zone” or the “frontage zone,” the building/ROW zone is the area between the PTZ and either the front wall of adjacent buildings or the edge of the public right-of-way. In downtown locations, it is the area where pedestrians stop to window shop, where people enter and exit buildings, where outdoor café seating is located, and where elevator hatch covers and building-mounted fire hydrants are sited. In residential areas, this

**Figure 3.21**  
*Defining  
Streetside Space*

Source: *Campaign to Make America Walkable* (Washington, DC, 1998).



<sup>36</sup>Washington DOT, *Pedestrian Facilities Guidebook*; City of Portland, *Portland Pedestrian Design Guide*; Campaign to Make America Walkable, *A Recommended Policy on the Management of Public Sidewalk Space*.



## MANAGING THE PEDESTRIAN THROUGH ZONE (PTZ)

area provides a buffer between hedges and fences that may be located on private property.

Ideally, there should be no intrusions in the part of a sidewalk intended exclusively for pedestrian travel: the pedestrian through zone (PTZ). As a general rule, the minimum width for the pedestrian through zone should be 8 feet in business and commercial areas with wide sidewalks, and 5 feet (or the full width) for local sidewalks. The items listed below are devices and activities that frequently compete with pedestrians for sidewalk space. Care should be taken to ensure that the primary purpose of the sidewalk—to provide for easy access by pedestrians—is given priority and maintained under all circumstances. This may require providing additional sidewalk space to meeting the minimum widths for the PTZ.

### *Surface Features*

It is important to note that even when the following surface features are located outside the PTZ, if they are still set in what may be considered the sidewalk, it is likely that some individuals will still walk over them, so care should be taken to install and maintain them accordingly.

- ◆ **Utility covers.**  
Should be located outside the PTZ. If this is not possible they should have a surface texture that is rough, with a slightly raised pattern. The surface should be slip-resistant, even when wet. The cover or hatch should be flush with the sidewalk surface.
- ◆ **Ventilation grates.**  
Should be installed on private property and should be prohibited in the PTZ.
- ◆ **Tree grates.**  
Should be installed and maintained flush with the sidewalk. They may be sited in either the RZ or BROWZ.
- ◆ **Elevator hatch covers.**  
Should be managed like utility covers.

### *Signs*

- ◆ **Traffic signs.**  
Should be located outside the PTZ, in the RZ and near the curb. The bottom of a sign should be at least 7 feet above the roadway or sidewalk.
- ◆ **Parking and transit signs.**  
Should be located in the RZ approximately 1.5 feet from the curb or, if the sidewalk abuts the curb, placed in the BROWZ or mounted directly on building face.
- ◆ **Information signs/kiosks.**  
Should be handled like transit signs or transit shelters.



- ◆ **Advertising signs.** No advertising signs, including temporary signs such as “sandwich boards” should be permitted in the PTZ at any time.

### *Parking*

- ◆ **Parking on the sidewalk.**  
At no time should any kind of motor vehicle parking be permitted on any portion of the sidewalk. This includes parking by delivery services, U.S. Postal Service vehicles, and utility company trucks.
- ◆ **Parking across the sidewalk.** Close attention should be given to ensuring that residents do not park motor vehicles in driveways so as to block sidewalks (which may be either adjacent to the curb or set back several feet).

### *Parking adjacent to the sidewalk:*

- ◆ **Parallel parking.** In most cases, the PTZ area of a sidewalk should not be located directly adjacent to the curb. In business districts and other high pedestrian volume areas where sidewalks may be paved up to the curb face, the PTZ should be set back at least 3 feet so that the resulting RZ provides a buffer between open car doors as well as a place for people to enter and exit parked cars.
- ◆ **Perpendicular and angle parking.** Care should be given to ensure that parked motor vehicles do not intrude into the PTZ. This can be done either by providing an adequate RZ to serve as a buffer between the curb and the PTZ, or by using wheel stops to restrict motor vehicle encroachment.
- ◆ **Valet parking.** In some commercial and entertainment districts, hotels and, increasingly, restaurants are providing customers with valet parking. The operation of this service, including temporary signs and stopping of motor vehicles should not be allowed to intrude on the PTZ at any time.
- ◆ **Bicycle parking.** Bicycle parking can take several forms: there are a wide variety of bicycle racks in use; bicycle lockers are sometimes made available for long-term (all day) parking at locations such as transit centers and universities; and bicycles are frequently “parked” informally by locking them to parking meters, trees, and sign poles. Designated bicycle parking devices should be located in either the RZ or BROWZ so as to keep bicycles out of the PTZ, and informal bicycle parking should not be allowed where it would intrude on the PTZ.



### *Street Furniture and Fixtures*

In some cases, where the space available for the sidewalk is limited by the building face on one side and the curb on the other, it may be necessary to construct a curb extension to accommodate uses such as transit shelters, utility poles, and signal controller boxes.

- ◆ **Benches.** Should be located outside the PTZ.
- ◆ **Public art/fountains.** Should not intrude on the PTZ.
- ◆ **Transit shelters.** Should be located in the RZ near the curb. Additional sidewalk width should be provided, as necessary, to preserve the PTZ.
- ◆ **Fire hydrants.** Should be located either in the RZ close to the curb or incorporated into the building face; they should not intrude into the PTZ.
- ◆ **Utility poles.** Should not be located in the PTZ. Where such poles do exist, the sidewalk should be extended around them on one side or the other to the full recommended width of the PTZ.
- ◆ **Signal controller boxes.** Should not intrude on the PTZ. If the available sidewalk space is absolutely limited (e.g., between a building front and curb face) then the curb should be extended to provide space for the box.
- ◆ **Planters.** Should not intrude on the PTZ. Also, care should be taken to ensure that planters are not designed nor placed so as to become a tripping hazard.
- ◆ **Trash receptacles.** Should ideally be placed in the RZ.
- ◆ **Mail boxes.** Should be located in the RZ.
- ◆ **Drinking fountains.** Should be located outside the PTZ, ideally in the BROWZ.
- ◆ **Parking meters.** Should typically be located in the RZ.

### *Other Features*

- ◆ **Elevators.** Elevators located between buildings and the street, and used to load and unload items, can present problems and threats to pedestrians. As previously noted, care must be taken in the installation and maintenance of elevator hatches to ensure that they are level with the sidewalk surface. Further, the surface of the hatch covers should be treated to ensure that they are not slippery when wet. Finally, it is important to “supervise” the use of elevators to ensure that when in use the open shaft does not pose a





serious threat to pedestrians and that materials are not temporarily stored on the sidewalk in such a way as to block the PTZ.

- ◆ **Temporary storage.** In some business districts, retail establishments may lack proper access at the rear of the store and products and produce may need to be loaded and unloaded through the front entrance. When this is the case, efforts should be made to encourage the business owners to 1) do this during non-peak pedestrian periods and 2) do this in such a way as to maintain easy access through the PTZ.
- ◆ **Snow storage.** At no time and under no circumstances should snow be removed from the roadway and deposited on a sidewalk so as to block the PTZ. Special attention should also be given to keeping corners at intersections and driveway entrances free of snow, and ensuring that snow removed from the roadway is not stored in such a way as to block a motorist's view of pedestrians.
- ◆ **Café seating.** Outdoor seating for restaurants can add to the general life and vitality of commercial areas. However, such seating should be located in the BROWZ and should not be permitted to intrude on the PTZ.
- ◆ **Merchandise displays.** In some jurisdictions, merchants may be permitted to display items for sale on tables or racks placed on the sidewalk. Care should be taken to limit this activity to the BROWZ and to ensure that neither the displays nor the likely customers intrude on the PTZ.
- ◆ **Street vendors.** In some jurisdictions, vendors may be permitted to operate on the sidewalk. This activity and associated customers should be kept clear of the PTZ.
- ◆ **Newspaper and other vending boxes.** While on the one hand, these devices can provide a convenient service to the public, on the other, they can constitute a physical and aesthetic intrusion on the public sidewalk space. Newspaper vending boxes should be restricted to legitimate news publications (i.e., boxes for “advertising publications,” such as real estate sales, should not be permitted in the public space). And, no boxes should be permitted to intrude on the PTZ nor placed in the “clear zone” at a corner.
- ◆ **Construction activity.** Various kinds of construction activity can impact the opportunity for pedestrians to have easy access along and across a street or highway. Care must be taken that this is not the case by ensuring that under all circumstances that pedestrians are provided with a sidewalk facility that meets at least the minimum specifications for the



PTZ. For instance, when a roadway or sidewalk reconstruction project takes place, a temporary sidewalk facility should be provided, just as is done for motor vehicle traffic. This is particularly true for projects involving bridges where there may otherwise be no alternate route for pedestrians. Another common situation in downtown areas involves major building construction projects. The work may impact on existing sidewalks in several ways: temporary removal of the existing sidewalk; placement of construction equipment, materials, or vehicles on the sidewalk; and the potential threat to pedestrians from construction activities. Regardless, provisions should be made to safely accommodate pedestrians during construction. This can be accomplished by providing a covered, temporary sidewalk facility using either the existing sidewalk or a portion of the roadway. This facility should be designed to protect pedestrians from noise and debris, should be well-lit, and should provide at least the minimum width of the PTZ.

- ◆ **Driveway entrances/exits.** Care should be used in the planning and location of driveways to minimize conflicts between motor vehicles and pedestrians. For instance, the layout of the driveway should be done in such a way that motorists do not block the PTZ while waiting to enter the roadway. Also, the building or parking lot entrance should be designed and landscaped in a way that ensures that entering and exiting motorists can readily observe the presence of pedestrians approaching the driveway. Finally, through the use of paving materials and other treatments it should be made clear to motorists that the concept is that they are driving on a sidewalk, rather than the idea that the pedestrian is walking across a driveway.

---

## Landscaping Guidelines

### *Landscaping and Street Trees*

Landscaping and street trees in planting buffers and along streets can greatly enhance the pedestrian experience, both in terms of esthetics and safety. Trees provide shade and shelter. They can also help slow motor vehicle traffic by better defining or “bounding” the roadway space. “Nature” or “green” strips serve as buffers between walkways and roadways, while providing areas not only for signs and utility poles, but for trees, flowers and shrubs. In residential areas, the maintenance of these areas is typically treated as the responsibility of the adjacent property owners. While this may generally work, local governments should monitor conditions to ensure that basic standards are met.

Landscaping and street tree plantings should follow the following guidelines:



- ◆ Plants should be adapted to the local climate and fit the character of the surrounding area. They should survive without protection or intensive irrigation, and should require minimal maintenance, to reduce long-term costs.
- ◆ Plants must not have growth patterns that would obscure pedestrians from motor vehicles-especially at crossing locations-nor should they be allowed to obscure signs. Use low-height shrubs and upward branching trees to maintain visibility and sight distance at intersections, driveways, crossings, and other critical areas along the street or highway.
- ◆ Plants should not have roots that could buckle and break sidewalks (root barriers should be placed to prevent such buckling).
- ◆ Street trees are typically spaced evenly along the street, ranging from 25 to 50 feet apart.
- ◆ Planting strips should be wide enough to accommodate the types of plantings contemplated. For instance, if large shade trees are to be planted, an arborist or forester may recommend 5 feet or more of space.

### ***Lighting***

Lighting of streets and highways-and of the adjacent sidewalks, walkways, and shoulders-increases pedestrians' safety, security and comfort and encourages walking. Typically, the street lighting system in urban areas provides adequate illumination for pedestrians, although conditions can be enhanced by providing such things as additional ground-level lighting.

Where a new lighting system is being introduced either to replace or supplement the existing street light system, it may be possible to incorporate light posts and fixtures that are more pedestrian friendly (shorter and more in scale with pedestrians, and with less harsh light sources). Additional lighting is usually desirable at pedestrian crossing points, such as at marked crosswalks, and at entrances to buildings.

It is generally recommended that a level of lighting between 0.5 and 2.0 foot-candles be provided along pedestrian travel ways. Check for established local standards; also, refer to the standards and design guidelines of the Illuminating Engineering Society of North America.<sup>37</sup>

### ***Maintenance***

Improper maintenance can hamper pedestrian safety and access and limit usage of pedestrian facilities. Typical problems include uneven pavement, standing water, overgrown shrubs and trees; sidewalk clutter (e.g., newspaper stands, vendors, portable signs and construction activity) and snow-covered walkways that aren't cleared promptly in winter. Damaged street furniture, damaged or missing signs, improperly functioning signals and worn pavement markings can create hazardous conditions for pedestrians.

<sup>37</sup>Illuminating Engineering Society of North America. New York, NY.



Effective inspection and maintenance management policies that address specific problems should be developed and enforced. Some will be directed at the private sector and others written for government agencies. Improving maintenance can require action on several fronts. The policies of all relevant agencies should be reviewed and changed, if necessary. Designers should be encouraged to consider maintenance from the beginning phases of a project. Outreach efforts should be initiated to involve the public in identifying and reporting areas in need of maintenance. Here are some steps that can be taken to improve the maintenance of pedestrian facilities.

- ◆ **Identify key implementers.** Implementation requires working closely with those agencies and personnel responsible for maintaining the current infrastructure, as well as those charged with designing and building new facilities. For walkway maintenance, this may mean the local public works department. For trails, it may mean local or state park and recreation agencies.
- ◆ **Determine which activities are the responsibility of the private sector and which are best handled by public agencies.** This will require researching existing policies and ordinances. New facility design can involve local engineering and park planning agencies as well as private developers.
- ◆ **Review existing policies and practices.** In some cases, an agency's policies, standards, and guidelines are included in formal documents that have gone through an approval process or that have been issued by department supervisors. Examples of these may be standard sweeping schedules and snow removal priorities.
- ◆ **Review results in the field and solicit comments from users.** In some cases, policies may seem reasonable in theory, but may break down in practice. For this reason, it is important to see how well the facilities work. Checking out the walkway system on foot can help uncover previously unknown problems. In addition, soliciting comments from users can help identify problems that would otherwise be overlooked. Because of their first-hand knowledge of conditions, pedestrians can often pinpoint specific needs and problem locations. To get such information, send news releases to the local media asking for help. In all likelihood, users will welcome the opportunity to contribute.
- ◆ **Conducting on-site visits will determine if current policies work.** If they don't, ask why not. Most likely the policies are not addressing the problems or they are not being properly implemented. Be careful not to impose unnecessary rules or act in a heavy-handed manner. For example, keep in mind that First Amendment rights allow newspapers to place their stands in public rights-of-way. The goal of



maintenance programs and activities should be to promote reasonable public safety and access, not to completely eliminate sidewalk “amenities” or to enrage property owners.

- ◆ **Recommend appropriate changes in policies and practices.** On the basis of the reviews and comments discussed above, develop modified versions of policies and practices where warranted. In addition, develop new guidance for adoption. Work with the appropriate agencies to make sure the changes are understood and implemented.
- ◆ **Create an ongoing spot improvement program.** As mentioned earlier, soliciting comments from users can help an agency find specific problem locations. Institutionalizing this process, in the form of a user-requested “spot improvement program,” can provide ongoing input and, in many cases, help identify problems before an injury occurs. In addition, such a program can dramatically improve the relationship between an agency and the public. Spot improvement programs are good policy and good public relations. To this end, set aside a modest annual budget allocation for user-requested spot improvements. Create mail-back postcards for distribution to community centers, schools, shops, and user groups. As cards come in, check out the locations identified and take action as necessary.
- ◆ **Evaluate progress.** As the work proceeds, keep track of successes and failures, as well as the schedule of routine maintenance activities. Identify changes that have or have not been made to policies and determine if additional effort is needed. On an annual basis, ask the public for comments on maintenance issues, in general, and the spot improvement program, in particular. In addition, keep track of the numbers and kinds of problems identified and how they were dealt with. Finally, determine if the program budget is appropriate to the task.
- ◆ **Develop an inspection and maintenance checklist.** Periodic inspections that identify problem areas are an essential feature of any maintenance program. The frequency of inspections will vary from region to region and with the nature of the maintenance activity. The adoption of an inspection and maintenance checklist outlining possible problems and appropriate solutions will help ensure adequate maintenance and repair for pedestrian facilities.
- ◆ **Uneven pavement and pavement with missing pieces.** Sections of walkway with a vertical pop-up of greater than 1/2 inch should be replaced or repaired temporarily with asphalt. In locations with a high volume of pedestrian traffic, especially wheelchair users, the pop-up should not exceed 1/4 inch.
- ◆ **Snow and ice buildup on walkways.** Walkways should not be used as snow storage areas for snow removed from streets. Local policies should treat the clearance of snow from walkways as being of equal

---

## Inspection and Maintenance Checklist



importance as clearance of snow from streets. In areas where abutting landowners and residents are responsible for clearing walkways, local regulations should be enforced. Curb ramps should be kept clear of snow accumulation from plowing.

- ◆ **Separated expansion and construction joints with a space between adjoining sections that is greater than 1/2 inch.** The gap can be filled with hardening expansion compound.
- ◆ **Loose sand and debris on the surface of the walkway.** Have the walkways swept and the debris removed. Where the abutting landowners and residents bear this responsibility, enforce local regulations to clean walkways.
- ◆ **Newspaper stands, portable signs, and other devices are creating barriers in a walkway.** The responsible parties should be required to remove the obstructions.
- ◆ **Walkways cracked and heaved by tree roots.** Have the failed sections removed, the roots cut and new sections of walkway installed. If the roots to be removed are large, contact an arborist to avoid injuring the tree.
- ◆ **Encroachment of overgrown trees, shrubs, grass, or weeds on walkways.** Local regulations that require abutting land users to perform timely clearance of vegetation that becomes an obstruction and/or limits sight distance should be enacted and enforced. As an alternative, private contractors can be hired to clear walkways and the costs assessed to abutting land owners.
- ◆ **Transition problems resulting from previous repairs.** Where the pavement surface from a prior repair has deteriorated, become cracked, or is missing altogether, remove the transition section and have all defective sections of pavement replaced.
- ◆ **Worn or slippery steps or ramp surfaces.** Steps and ramp surfaces that have become worn and slippery should be overlaid, textured, or replaced to create a slip-free and unbroken surface.
- ◆ **Worn paint on stop bars and crosswalks.** Develop a policy for regular inspection and refurbishment of paint on crosswalks and stop bars.
- ◆ **Missing or damaged signs.** Periodically check for missing or damaged signs and other traffic control devices.
- ◆ **Improperly functioning pedestrian signals.** Inspect pedestrian signals periodically for proper operation; clean lenses and replace bulbs as necessary.



The development of a ongoing maintenance management program will also greatly curtail the risk of liability. However, the primary goal of a maintenance management program should not be to avoid liability but to control the risk of injury to pedestrians. The most important step that any government entity can take to reduce potential liability is to reduce crashes. By developing a competent maintenance and risk management program, a government entity will not only be benefiting its residents and users, it will also be helping to assure the taxpayers it is doing all that it can to be responsible stewards of the public treasury. Additional suggestions for managing risk:

- **Develop written maintenance procedures and follow them.**

Remove all hazards. If a hazard cannot be removed, protect it with barriers or clear warning signs.

- **Monitor pedestrian facilities.**

Inspect facilities regularly using trained and experienced maintenance personnel. Investigate all reports of hazards from all sources. Review crash reports to determine whether hazardous conditions exist.

- **Keep a report of maintenance activities and inspections.**

Such records may become significant in liability actions that take place at a later date.



## 4.1 WHAT IS “TRAFFIC CALMING?”

### SECTION 4

Traffic calming

Transit

School-related issues

Trails and Greenways

RETURN TO  
TABLE OF CONTENTS

**T**raffic calming involves the use of various roadway design treatments to reduce motor vehicle speeds and traffic volume. It is most often used on residential and downtown streets, although there is increased use of traffic calming techniques to help manage motor vehicle speeds on collector and arterial streets. When traffic calming techniques are applied on a neighborhood-wide basis, rather than in isolated locations, the behavior of motorists tends to be more significantly influenced and the traffic problems of the area are more generally improved, as opposed to simply shifting them from one location to another. While traffic calming is not initiated expressly for pedestrians, the effects—slower motor vehicle speeds and reduced motor vehicle volumes—can significantly improve the pedestrian environment. High-speed traffic is intimidating to pedestrians and it shortens reactions times for drivers. The higher their speed, the less likely drivers are to yield or stop for pedestrians. And, when crashes occur, the higher the speed of motor vehicles the more severe the injuries are to pedestrians.

Simply lowering the posted speed limit may seem like the most logical strategy for slowing traffic. However, it is generally accepted that it is the design of the street, and not the posted speed limit, that determines how fast people drive. People drive faster on roads that are wide, that lack sharp turns, and that allow the driver to see a longer distance ahead. Wide, visually uninterrupted roadways send the message that “this road is for cars.” It encourages motorists to increase their travel speed and lulls drivers into paying less attention to pedestrians.

The problem with excessive motor vehicle speed in neighborhoods, downtown shopping areas, and on many other streets stems from the fact that while a certain speed limit (e.g., 25 mph posted speed) is designated for the street, typically the highway designer adds in a big “safety” margin by designing a street that will permit much faster traffic (e.g., 45 mph design speed). Research has shown that most motor vehicle operators will, in the absence of regular traffic enforcement, drive at the design speed, not the posted speed. Traffic calming was developed as a way of “re-engineering” streets and highways to reduce the operating speeds of motor vehicles.

It is important to note that the best approach to traffic-calming is to change the basic design of streets so that motor vehicle operating speeds are appropriate and compatible with the area and its related activities. For instance, streets in residential areas, in downtown shopping areas, near schools and parks, and other places where pedestrians — especially children — are likely to be should be designed to limit motor vehicle





speeds to 15 to 25 mph. Currently, most communities in the metropolitan Kansas City area require a 50-foot minimum right-of-way with a pavement width of 28 feet in residential areas. This design can be expected to induce driving speeds well in excess of what is appropriate and desired in such areas. Narrower streets and rights-of-way, together with the use of street trees and medians, can have a significant effect on keeping motor vehicles speeds down. This helps to create both safer and more attractive conditions for walking.

#### TRAFFIC CALMING POLICY

When planning to implement traffic calming or area-wide traffic management strategies of any sort, care should be taken to get the input of stakeholders and affected citizens. Neighborhood traffic controls and calming devices can be useful tools in achieving community goals, whether they be broad goals for livability, or specific traffic reduction targets. Consider adopting a set of policies to guide the planning and implementation of traffic calming measures.

---

#### Recommended Policies for Traffic Calming

- ◆ Through traffic should be encouraged to use arterial streets, and discouraged from collector and neighborhood streets.
- ◆ Education, enforcement, and engineering methods should be considered as part of any traffic-calming project. Traffic-calming devices should be planned and designed in keeping with sound engineering and planning practices.
- ◆ Emergency vehicle access should be evaluated and planned for as part of the overall traffic management plan.
- ◆ Reasonable automobile access should be maintained. Pedestrian, bicycle, and transit access should be encouraged and enhanced wherever possible.
- ◆ Parking removal should be considered on a project-by-project basis. Parking needs of residents should be balanced with the equally important functions of traffic, emergency vehicle access, transit, bicycle, and pedestrian movement.
- ◆ Application of traffic-calming will be primarily on residential and collector streets; in some cases, traffic-calming may be appropriate on arterial streets where there is a clear need to accommodate pedestrian traffic.
- ◆ Traffic-calming projects on collector streets should not divert traffic off the street (e.g., through the use of traffic diversion devices).
- ◆ Traffic may be rerouted from one local street to another as a result of a traffic-calming project. The acceptable traffic increase should be defined on a project-by-project basis.



- ◆ To implement a local traffic-calming program, certain procedures should be established for processing traffic calming requests. At a minimum, the procedures should provide for submittal of project requests; project evaluation and selection; citizen participation; and communication of any test results and specific findings to project area residents and affected neighborhood organizations before installation of permanent traffic calming devices.

Source: Based on City of Portland, *Traffic Calming Program Guide* (Portland, OR, 1996).

## TECHNIQUES

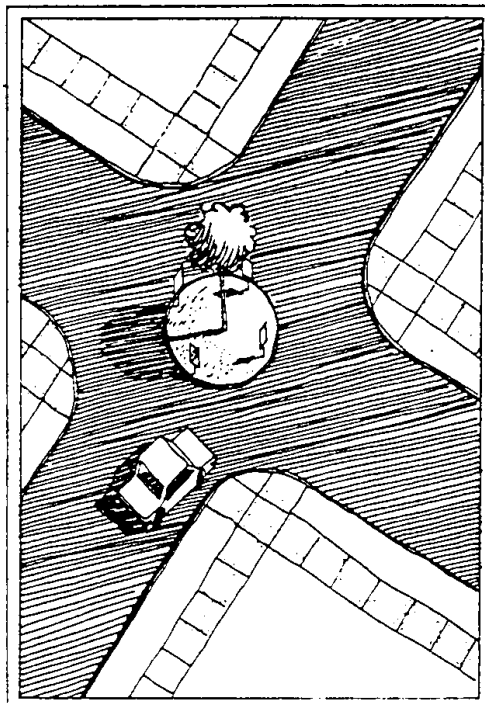
There are a number of design techniques that involve either changes in the horizontal or vertical profile of the roadway that can be used to traffic-calm streets and make them more pedestrian-friendly (see figure 4.2).

Speed humps are used to slow motor vehicle traffic by changing the horizontal alignment of the roadway. A wide variety of designs-varying height, width, and frequency-have been developed to help slow motor vehicle speeds to the posted limit.

Traffic circles or roundabouts are raised islands placed at the center of an intersection to slow high-speed traffic on neighborhood streets (see figure 4.1). The City of Seattle has found that traffic circles reduce motor vehicle accidents 90 percent at intersections.<sup>36</sup>

**Figure 4.1**  
*Residential Traffic  
Circle at Four-way  
Intersection*

Source: Washington Department  
of Transportation, *Pedestrian  
Facility Guidebook*.



<sup>36</sup>Peter Lagerwey, 1993[City of Seattle, need more information]



Curb extensions or “curb bulb-outs” narrow the roadway at crosswalks by extending the sidewalk to make pedestrian crossings easier. Curb bulbouts also provide drivers with a visual cue that the space is shared, and makes the waiting pedestrian more visible. The shorter crossing distance reduces the time pedestrians are exposed in the roadway, and gives them a better view of approaching traffic.

Neckdowns are landscaped islands that extend from the curb onto the roadway, often to line up with parallel-parking lanes. They break the road into smaller visual unities, intruding into the road to form a narrowed “gate.”

Chicanes are partial barriers staggered on alternate sides of the roadway that force motorists to slow down to manage the narrow changes in direction.

Gateways or entrance islands are used to define a transition between an arterial and local street by conveying a strong visual message to motorists that they are entering a special area and that they should slow down. Interrupted sight lines prevent motorists from seeing a long way into the distance, which tends to force them to reduce their speed. Two common ways of interrupting sight lines are to incorporate “S” bends into the roadway or to use on-street parking and neckdowns in a staggered fashion to create bends in the vehicle traffic flow.

Raised medians are elevated strips, often landscaped, that run mid-road, parallel to traffic. Installing them has the effect of narrowing the roadway space devoted to vehicles, as well as providing pedestrians a refuge when crossing the street.

Diagonal diverters are barriers that extend diagonally across residential intersections. They are used to reduce “cut-through” traffic, but can cause inconveniences for neighborhood residents’ access. Full diverters are placed diagonally across the entire intersection. Semi-diverters extend just halfway across the intersection, preventing vehicles from entering a street in one direction.

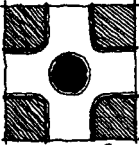
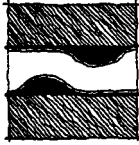
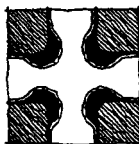
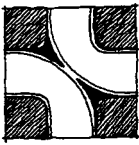

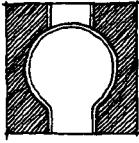
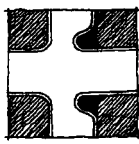
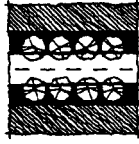
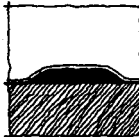
Trees, when planted close to the street, visually narrow the apparent street width as they mature. They also “soften” a landscape that is dominated by pavement and enhance the quality of the pedestrian (and neighborhood) environment.

Changes in road surface, including changes in paving materials or color, can make the roadway appear narrower than it is and can augment the visual message telling drivers to slow down. Textured crosswalks, for example, help call notice to the possibility of pedestrian crossings. Speed tables are slightly raised sections of the roadway, like speed humps but significantly longer. When a vehicle has crossed midway over a speed table, both sets of wheels are on the raised surface. Speed tables are increasingly being used at intersections, frequently combined with changes in the road surface.



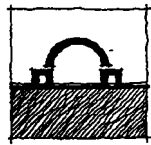
**Figure 4.2**  
*Traffic Calming*  
*Design Treatments*

Source: City of Seattle Engineering Department, *Making Streets that Work* (Seattle, WA, 1996).

DRAWING	TECHNIQUE	DESCRIPTION
	TRAFFIC	Circular raised islands centered within intersections. Circles can be landscaped or surfaced with special paving. Landscaping can be maintained by the local jurisdiction or by neighborhood volunteers.
	CHICANES	Alternately placed curb extensions into the street that force motorists to drive in a serpentine pattern. Chicanes are offset from each other in mid-block locations and can be used to keep through-trucks versus local delivery off residential streets.
	CURB BULB-OUTS. CHOKERS/ NECKDOWNS	Curb extensions placed at mid-block locations or intersections which narrow the street to provide visual distinction to and reduce pedestrian crossing distances. Bulb-outs help to provide a clear visual signal to drivers that a crossing is approaching and makes waiting pedestrians more visible. Neckdowns are often longer than bulb-outs and often line-up with and help to define parallel street parking areas. They narrow the appearance of the street and can be attractive, especially when landscaped.
	DIAGONAL DIVERTERS	Eliminates through traffic while providing partial access in opposite directions; island can become amenity and provide refuge for pedestrians.
	FORCED TURNS AND PARTIAL DIVERTERS	Truncated diagonal diverters (one end remains open) and other types of partial diverters discourage commuter traffic by forcing turns but provides local access opportunities.
	CUL-DE-SAC/ STREET CLOSURES	Street is closed and turned into a cul-de-sac; end of street becomes a neighborhood amenity and focal point (landscaped mini park); the ongoing provision of pedestrian and bicycle access is important.
	ONE-WAY ENTRY AND EXIT	Curb bulbs/ extensions are used to close one lane of traffic at intersections; stops through traffic but allows ingress or egress depending on the direction and location of the closure.
	NARROWER STREETS	Narrower streets limit the expanse of pavement visible to the driver and can be effective in slowing traffic, especially when lined with trees or on-street parking.
	SPEED HUMPS/ TABLES	A speed hump is wider and smoother than a speed bump, and effective in slowing cars as they approach pedestrian zones. These are most appropriately used on neighborhood streets.

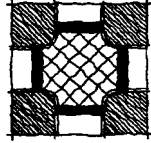


**Figure 4.2**  
*Traffic Calming*  
*Design Treatments*  
 — Continued



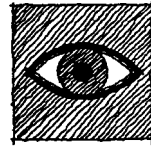
**SIGNS AND NEIGHBORHOOD GATEWAYS**

Signs such as “Residential Street,” “Local Access Only,” or monuments that identify neighborhood districts can be effective, especially when used in conjunction with other techniques, including those listed above and others, such as pavement markings and textured warning strips.



**SPECIAL PAVING**

Alternative road surfaces, such as brick, colored concrete or special pavers, can be used at crossings, intersections or along the sides of the street to break up the visual expanse of pavement and define areas of pedestrian travel.



**SPEED WATCH PROGRAMS**

Citizens and organizations can utilize a radar device and electronic sign board to measure speeds of passing vehicles in their neighborhoods. Letters of warning can be sent to the registered owners of offending vehicles. These programs promote neighborhood cooperation.

There are several good guides to the design and use of traffic-calming techniques currently available:

**RESOURCES**

- ◆ **American Planning Association.** *Traffic Calming*, PAS 456. 1995. APA, 122 S. Michigan Ave., Suite 1600, Chicago, IL 60603.
- ◆ **Federal Highway Administration.** *Traffic Calming, Auto-Restricted Zones and Other Traffic Management Techniques, Case Study No. 19* (Publication No. FHWA-PD-93-028). 1994. National Bicycle and Pedestrian Clearinghouse, 1506 21st Street NW, Washington, DC 20036.
- ◆ **Public Technology Inc.** *The Community Guide to Traffic Calming*. 1996. PTI, 1301 Pennsylvania Ave. NW, Washington, DC 20004.
- ◆ **City of Seattle.** *Making Streets That Work: A Neighborhood Planning Tool*. 1996. Seattle Engineering Department, 600 Fourth Ave., 12th Floor, Seattle, WA 98104.

**4.2**  
**TRANSIT**

**T**ransit can include several types of transportation modes, including public bus services, commuter and light rail lines, and van pools. Expanding access to transit and improving transit facilities are complementary to promoting pedestrian travel as an alternative transportation mode. This section discusses improving transit facilities for pedestrians and designing transit stops to better serve pedestrians. These improvements will encourage both transit use and higher levels of walking.



## IMPROVING TRANSIT FACILITIES FOR PEDESTRIANS

The success of transit as a mode of transportation is highly dependent on pedestrian access. People with disabilities may rely on transit as their primary source of transportation, and transit facilities need to be designed to meet their needs. The following design guidelines will help encourage and improve transit access for pedestrians.

---

### Guidelines for Transit Access

- ◆ Provide sidewalks, walkways, or informal paths on streets with bus routes that lead to transit stops.
- ◆ Design sidewalks that access transit with a minimum 5-foot width; this enables two people to walk comfortably side by side.
- ◆ Provide a 9-foot-long by 5-foot-wide landing pad at bus entrances and exits, as required by the ADA for some bus stop locations.
- ◆ Encourage transit use by providing shortcuts that reduce the distance a pedestrian must walk. Bridges over streams, paths through parks and neighborhoods, and walkways that connect to dead-end streets can provide expanded access opportunities for pedestrians.
- ◆ Provide well-lit access ways to transit facilities, since transit riders often commute to work or school in early morning and late afternoon and evening hours.
- ◆ Keep pedestrian signals and other traffic control devices operational and set with timings that allow pedestrians to comfortably cross streets to reach transit stations and bus stops.
- ◆ Create space directly adjacent to bus loading areas that is free of all street-level obstacles.
- ◆ Provide shelters and covered structures, where feasible, to protect passenger waiting areas from wind and precipitation.
- ◆ Maintain an open sight line between the bus operator's view and the passenger waiting and loading areas. Shelters should be constructed with windows and clear materials to provide a view of the waiting passengers inside.
- ◆ Provide accessibility to people with disabilities with curb cuts, ramps, and clearly defined and delineated pedestrian space.
- ◆ Install street furniture that is durable and vandal-resistant.

Source: Washington DOT

## TRANSIT STOPS

Certain considerations for pedestrians should be made when designing bus stops.

---

### Guidelines for Bus Stops

- ◆ Provide a minimum 4-foot-wide clearance zone from the curb so that opening bus doors are not blocked by street furnishings, sign posts, landscaping, or other obstructions.



- ◆ Provide open sight lines and avoid placing shelters, furnishings, and vegetation in a way that may obstruct driver and waiting passenger views.
- ◆ Provide well-lit, secure shelters for transit riders that offer protection from weather, and are constructed of materials that do not obstruct views out of or into the shelter.
- ◆ Provide sidewalks within designated bus zones, with a loading areas for wheelchair access to transit services.
- ◆ Make provisions for transit riders to cross the road safely at transit stops. On a typical two-way street, with residences and development on both sides, many of the riders will need to cross the road when boarding or exiting the bus. Mid-block crossing facilities should be provided, as necessary, at mid-block bus stop locations.
- ◆ Avoid bus stop design that conflicts with other types of uses. For example, bus stops should not interrupt bike lanes, and waiting areas and shelters should be provided to the side of the walkways so that pedestrians can pass passengers waiting to board.
- ◆ When there is a planting strip directly adjacent to the curb, provide a sidewalk slab that extends from the existing sidewalk to the curb so that passengers do not have to cross wet grass or mud during inclement weather.
- ◆ Ensure that all transit stops are easy to reach from walkways.

#### RESOURCES

- ◆ Federal Highway Administration. *Linking Bicycle / Pedestrian Facilities with Transit, Case Study No. 9* (Publication No. FHWA-PD-93-012). 1992.
- ◆ National Bicycle and Pedestrian Clearinghouse, 1506 21st Street NW, Washington, DC 20036.

### 4.3 SCHOOL-RELATED ISSUES

Children are involved in a greater percentage of pedestrian crashes than they are a percentage of the general population. This is not entirely surprising for three reasons. First, they don't have the same ability to deal with traffic as adults do. Second, most motor vehicle operators do not slow down or otherwise take special care when children are present near the roadway. Third, in many situations children are forced to walk in or very near the roadway and to cross busy streets with inadequate provisions for safety. This section will explore some of the things that can and should be done to make it safer and easier for children to walk to school.



**ABOUT CHILDREN  
AS PEDESTRIANS**

One of the most oft-repeated observations by traffic safety professionals when talking about children is that “kids are not short adults.” Children have limitations that must be kept in mind. Research has shown that adults—both as motor vehicle operators and as highway design and traffic engineers—regularly overestimate a child’s ability to deal with traffic, especially when crossing the street. The fact is that most children under the age of 10 do not have the necessary skills to safely deal with faster moving traffic when trying to cross the street.

---

**Typical Limitations  
of Children  
aged 5 to 9**

- ◆ Children are shorter than adults; typical eye height is 3 feet above ground; their field of vision is different as well.
- ◆ Children have one-third narrower side vision than adults and are less able to determine the direction of sounds.
- ◆ Children have trouble judging speeds and distances of moving cars. In fact, research has shown that up to the age of 10, most children only consider how far away a car is when judging if it is safe to cross the street; they do not take into consideration how fast the car is moving.
- ◆ Children are sometimes too small to be seen by fast-moving or inattentive drivers.
- ◆ The movements of children are predictably unpredictable.
- ◆ Children have shorter attention spans and will quickly grow impatient when waiting to cross the street.
- ◆ Children have less experience as pedestrians than adults and may not be fully aware of dangerous conditions.

**SCHOOL SITE SELECTION**

Schools have traditionally been one of the focal points of the community, serving as a place of education and providing recreation facilities, meeting and voting space, and accommodating other community services. Siting a school so it can be easily reached from all directions and providing a sufficient level of pedestrian facilities in the vicinity of the school further help to establish it as a strong center of the community. School sites should be centered in the community and accessible to pedestrians from all sides. Streets leading to school sites should be designed to include full sidewalk or walkway improvements and other elements that contribute to pedestrian safety and comfort (traffic-calming to slow traffic, good lighting, clear visibility, and trees for shelter and shade). Intersections and crossings within the vicinity of the school need to be well designed, with a focus on the needs of student pedestrians.

Generally, schools should not be located on high-speed, high-volume arterial streets; low-traffic locations well within neighborhoods are preferable. Parking for all types of schools should be minimized; people should be encouraged—and expected—to walk or bike to school.





The proper planning, design, and retrofit of school sites entails consideration of many factors (see figure 4.3). Certain sites may pose unique challenges that require special treatments. The ITE is currently preparing a report on traffic circulation and safety at school sites.<sup>37</sup> Some of the basic principles of good school site design related to pedestrians are listed below.

---

### Elements of Good School Site Design

- ◆ Pedestrian access is treated as the highest priority for access to and on the school site.
- ◆ Surrounding streets are equipped with sidewalks and marked crosswalks.
- ◆ The building is accessible to pedestrians from all sides (or at least, from all sides with entries/exits).
- ◆ Trails and pathways provide direct links between the school site and the surrounding neighborhoods.
- ◆ Bus drop-off zones are separated from auto drop-off zones to minimize confusion and conflicts.
- ◆ Buses, cars, bicycles, and pedestrians are separated on the site and provided with their own designated areas for travel.
- ◆ Pedestrian travel zones (sidewalks, crosswalks) are clearly delineated from other modes of traffic through the use of striping, colored and/or textured pavement, signing, and other methods.
- ◆ Parking is minimized; people are encouraged to walk to school.
- ◆ Pedestrians are clearly directed to crossing points and pedestrian access ways by directional signing, fencing, bollards (barrier posts) or other elements.
- ◆ Frequent, well-delineated crossing opportunities are provided, including marked crosswalks (and crossing guards at higher-speed roadways for younger students) at controlled intersections and mid-block locations.
- ◆ Traffic-calming devices are installed in the school service area to keep motor vehicle speeds at appropriate levels.
- ◆ View obstructions are avoided so there is clear visibility of pedestrians throughout the area.

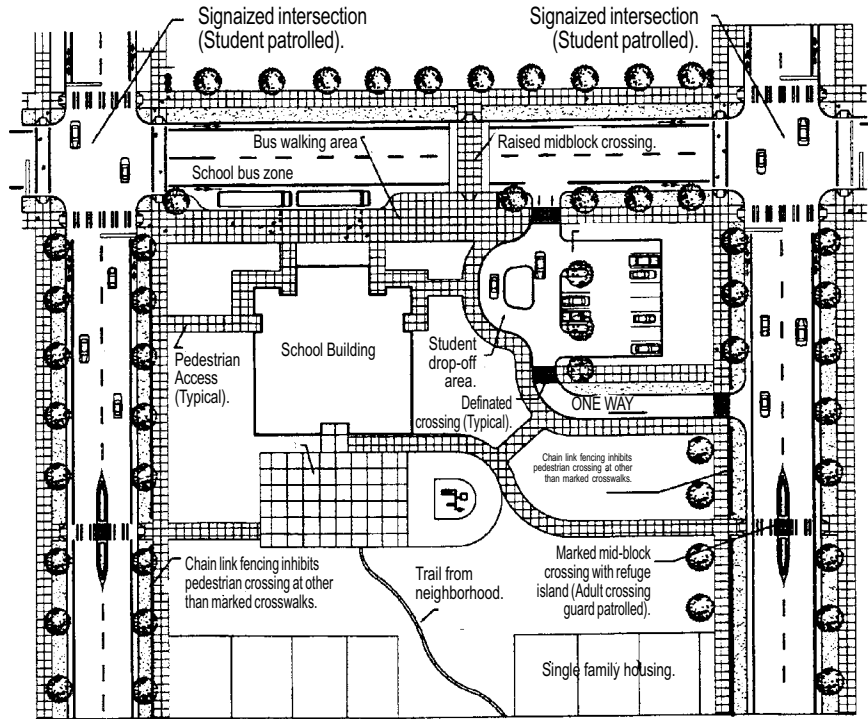
Source: Based on Washington DOT, *Pedestrian Facilities Guidebook* (p. 53).

<sup>37</sup> ITE Journal (November, 1998), p. 24.



**Figure 4.3**  
*Typical Aspects of  
 School Site Design*

Source: Washington Department  
 of Transportation, *Pedestrian  
 Facility Guidebook*.



**PEDESTRIAN ACCESS  
 ROUTES TO SCHOOL**

Sidewalks and walkways that clearly define the routes of access to and from schools should be provided in all areas surrounding the school and on the school site. Vertical separation (with curbs) and horizontal separation from motor vehicle traffic (sidewalk set-backs, planting buffers, ditches, and swales) are strongly encouraged to improve the safety of pedestrians walking along streets. On roads without sidewalks (often the case in rural areas surrounding schools), widened roadway shoulders accommodate pedestrians. At a minimum, shoulders that are part of a designated school walking route should be 5 feet wide and be provided on both sides of the road.

The ITE has published a “Recommended Practice” detailing recommended guidelines for school trips and operation. It states, in part, that local and state agencies should adopt guidelines for the safety of school children, which includes the selection of safe walking trip routes to school and traffic control measures, and provides the following guidance on how to do so:

*“A committee at the local level should be responsible for the for the appropriate and uniform application of school crossing protection measures. Committee members might represent the school, police, parent/teacher association, engineering department, mayor’s traffic safety committee, etc.”<sup>38</sup>*

<sup>38</sup> ITE, [Ped Guide] p. 84-87.



---

## Six Steps in Developing a School Safety Program

1. Set up the school trip safety process.
2. Identify deficiencies in routes.
3. Designate a route map for the safe route to school.
4. Selection of route improvements and control measures.
5. Implement route improvements.
6. Periodically evaluate routes.

Source: ITE, *School Trip Safety Program Guidelines*, ITE Journal (1985)

Another useful tool in assessing current conditions around school sites is the “Walkable America Checklist” from the Partnership for a Walkable America (PWA).<sup>39</sup> The checklist is intended to be completed by parents and their children, ideally in conjunction with walking together to school. Another PWA program, Walk a Child to School,<sup>40</sup> can serve as a good community-based event to help promote public awareness of, and action on, conditions related to children walking to school.

### 4.4 TRAILS AND GREENWAYS

Well-planned and designed multi-use paths can provide good pedestrian access and mobility, especially when planned to compliment the network of sidewalks. Trails can be developed along streams and other types of greenways, and be components of a community-wide trail system. Although most of these facilities were originally designed for bicyclists, it is generally recognized that trails and multi-use paths are used by pedestrians, joggers, and skaters as well. The planning and design of multi-use paths must therefore take into account the various capabilities, needs, and characteristics of these different users.

---

### Key Components to Successful Trails

- ◆ Continuous separation from traffic by locating paths along a stream or a greenway such as a rail-to-trail conversion, with few street or driveway crossings (paths directly adjacent to roadways are not recommended, as they tend to have many conflict points).
- ◆ Scenic qualities, offering an aesthetic experience that enhances the experience for pedestrians.
- ◆ Connections between a range of land uses, such as shopping areas, parks, schools, and other community facilities.

<sup>39</sup>The checklist was developed with support from the National Highway Traffic Safety Administration. Copies are available from the National Bicycle and Pedestrian Clearinghouse, 1506 21st Street NW, Washington, DC 20036.

<sup>40</sup>For more information, contact PWA, c/o National Safety Council, 1121 Spring Lake Drive, Itasca, IL 60143.



- ◆ Well-designed street crossings, with measures such as bike- and pedestrian-activated signals, median refuges, and warning signs for both motor vehicles and path users.
- ◆ Potential for offering routes with shorter trip lengths than the road network, with connections between dead-end streets or cul-de-sacs, or as shortcuts through open spaces.
- ◆ Visibility: Proximity to housing and businesses increases safety. Despite fears of some property owners, paths have not attracted crime to adjacent neighborhoods.
- ◆ Good design, by providing adequate width and sight distance, and avoiding problems such as poor drainage, blind corners and steep slopes.
- ◆ Good signage to direct trail users.
- ◆ Proper maintenance, with regular sweeping and repairs.

#### TRAIL WIDTH AND CLEAR ZONES

The recommended width for a two-way multi-use path is 10 feet; such paths should be 12 feet wide in areas with high levels of use. The minimum width is 8 feet. However, 8-foot-wide multi-use paths are not recommended in most situations. They should only be constructed as short connectors, or where long-term usage is expected to be low, and with proper horizontal and vertical alignment to assure good sight distances.

A “shy” distance or clear zone of 3 feet or greater (minimum 2 feet) on both sides of a multi-use path is necessary for safe operation. This area should be graded to the same slope as the path. The standard clearance to overhead obstructions is 10 feet (minimum 8 feet). Where a path is parallel and adjacent to a roadway, there should be a width of 5 feet or greater separating the path from the edge of roadway, or a physical barrier of sufficient height should be installed.

#### TRAIL SURFACE

The use of asphaltic concrete surfacing for paths is best for accommodating the full range of likely users. Asphaltic concrete provides a smooth surface when placed with a slip-form paver. Portland cement paths cost more to build than asphaltic concrete paths, but long-term maintenance costs may be lower, since they do not become as brittle, cracked and rough with age, or deformed by roots and weeds as does asphaltic concrete. Portland cement surfaces may be appropriate when pedestrians only (i.e., no bicycles or skaters) are expected to use the facility.

Multi-use paths should be designed with sufficient surfacing structural depth for the subgrade soil type to support maintenance and emergency vehicles. If the path must be constructed over a very poor subgrade (wet and/or poor material), treatment of the subgrade with lime, cement or geotextile fabric should be considered.

All vegetation, including roots, must be removed in the preparation of the subgrade. Special care is needed to control new growth, such as the



use of soil sterilant or lime treatment of the subgrade. Paths built in wooded areas present special problems. The roots of shrubs and trees can pierce through the surface and cause it to bubble up and break apart. Preventive methods include removal of vegetation, realignment of the path away from trees, and placement of root barriers along the edge of the path. An effective barrier is created with a 12-inch-deep metal shield; greater depth is required for some.

#### GRADE AND CROSS-SLOPE

On paths intended for use by pedestrians, ADA requirements must be met: the grade should not exceed 5 percent, to accommodate wheelchair users. ADA does allow for steeper grades, but requires provision of level “staging areas” at regular intervals. The standard cross-slope grade is 2 percent, to meet ADA requirements and to provide drainage.

#### DRAINAGE

Drainage is an important consideration in trail design and construction. If not addressed properly, it can become the single biggest maintenance cost, and greatest cause of problems that deter users. For on-site runoff resulting from rainfall, the design objective is to maintain the water-flow level that existed before the corridor was developed. During trail construction, do not alter or obstruct any off-site runoff from adjacent or intersecting streams.

There are two types of drainage flow: surface water runoff and subsurface water runoff. The ideal way to mitigate surface runoff is through an open system using swales (shallow drainage channels adjacent to trail), ditches, or sheet flow combined with on-site detention ponds. Subsurface drainage can be managed through the use of pipes, French drains, or sloped and contoured drainage channels. For successful, cost-effective drainage solutions, work with trained landscape architects, engineers, or a local Natural Resources Conservation Service office throughout the design process.

#### STRUCTURES

The width of multi-use path structures should be equal to, or greater than, the approach paved path, plus a 2-foot shy distance on both sides. For example, a 10-foot-wide path requires a 14-foot-wide structure. The standard overhead clearance of underpass crossings is 10 feet; an 8-foot minimum may be allowable with good horizontal and vertical clearance, so users approaching the structure can see through to the other end. Underpass crossings should be visually open for the personal security of users. Supplemental lighting may be needed in areas of poor visibility.

---

### Underpass Crossings

There are advantages and disadvantages to both underpass crossings and overpass crossings.

**Advantages.** They provide an opportunity to reduce approach grades, as the required 10-foot clearance is less than the clearance required for crossing over a roadway. If the roadway is elevated, an underpass crossing can be constructed with little or no grade. They are often less expensive to build.



**Disadvantages.** They may present security problems, due to reduced visibility. An open, well-lighted structure may end up costing as much as an overpass crossing. They may require drainage if the sag point is lower than the surrounding terrain.

---

## Overpass Crossings

**Advantages.** They are more open and present fewer security problems.

**Disadvantages.** They require longer approaches to achieve the standard 17-foot of clearance over most roadways. With an additional structural depth of 3 feet, the total rise will be 20 feet. With a maximum grade of 5 percent, this requires a 400-foot approach ramp at each end, for a total of 800 feet. This can be lessened if the road is built in a cut section.

---

## Bridges

Bridges are among the most challenging design elements of multi-use trails, in part because each one is site specific. Safety is the primary concern in bridge design, and therefore, its design load-the bridge's structural capacity to support predictable forces and weights during its projected life span-must be properly determined. Consider both the dead load (the total weight of all bridge components) and the live load, which is the active forces and mass the bridge is designed to support (people, emergency vehicles, flood waters, snow).

As a rule, bridges should be designed to support at least the same live load that the rest of the trail has been designed to support, typically a minimum of 12,500 pounds. AASHTO's Standard Specifications for Highway Bridges provides good information about dead and live loads. These guidelines, however, were developed for highway bridges and can result in an "overdesigned" (and more costly) bridge. Many trails use prefabricated bridges, which are constructed off-site by a bridge manufacturer, delivered to the site, and lifted onto appropriate footings by a crane.

An exception can be made to this load recommendation when both sides of the bridge are accessible to emergency and maintenance vehicles. If a corridor already contains a bridge it probably can be adapted for trail use by adding bridge decking and railings and adjusting bridge approaches. While some bridges are decked with poured concrete, most are surfaced with 4-inch pressure-treated planks that are laid at an angle between 45 and 90 degrees to the direction of travel.

The most neglected element of bridge design is the approach, which should be constructed in the same manner as the bridge, but with posts installed in the ground rather than to the superstructure. For safety reasons, and because bridges are a natural stopping point for trail users, approach railings should extend 15 feet from each end of the bridge and should be flared out. Additionally, 90 degree turns (or any sharp curves) should be avoided at the bridge approaches.

## ACCESS CONTROLS

At points where a trail intersects with a roadway, it may be necessary to provide some form of "access control" to help ensure that unauthorized motor vehicles do not turn onto the path. One method to accomplish this is to divide the trail into two narrower one-way paths just before it reaches the roadway.



Another technique involves the use of short curb radii (5 feet) to make it difficult for motorists to enter a path from the roadway.

Bollards, or barrier posts, may be used to limit vehicle traffic on paths. However, cyclists may find them hard to see and they should be used with caution. When used, they should be spaced wide enough (minimum 5 feet) for easy passage by pedestrians, cyclists, and bicycle trailers as well as wheelchair users. A single bollard is preferred, as two may channelize bicyclists and pedestrians to the middle opening, creating conflicts. Bollards should not be placed immediately adjacent to the intersection. They should be painted with bright, light colors and otherwise marked to increase their visibility, especially at night.

## **SUPPLEMENTAL FACILITIES**

As with other pedestrian areas, multi-use pathways should include occasional rest areas and benches. Rest areas should include drinking water accessible by wheelchair adjacent to but separated from the pathway and clear area. Because trails are often developed in separated rights of way, access to potable water is very important along multi-use trails, especially during warm weather months. Drinking water should be available at trail heads and, where possible, along the trail facility. Simple mile markers can be useful to all path users, particularly those engaged in fitness activities. In addition to these markers, fitness equipment can be provided along the trail to encourage physical activity and exercise. Pull-up bars, sit-up benches and the like can be arranged in a physical fitness “challenge course.”

Public telephones should be located within one hundred yards of trailheads and at rest areas, in case of emergency. If loitering becomes a concern, emergency call boxes can be used in place of public telephones.

## **SIGNAGE**

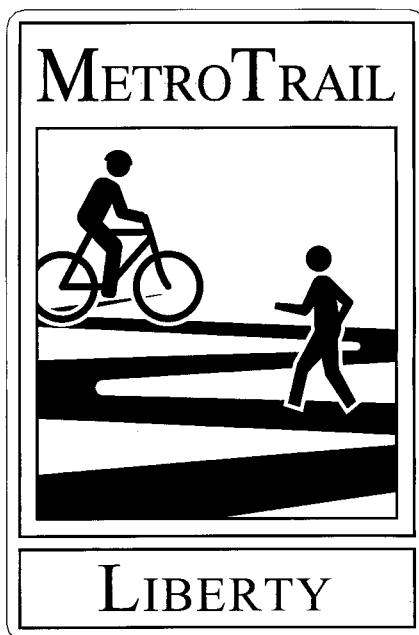
There are three types of signs that enhance the function and use of trail facilities: warning signs, directional signs, and information signs. Warning or caution signs should be used to alert trail users to any potential hazards. For instance, pedestrians should be alerted to an upcoming curve with restricted sight distance where extra care should be taken. Similarly, use warning signs to remind pedestrians to be attentive to motor vehicles when a trail crosses an at-grade roadway.

Directional signs should be used to help guide pedestrians and other trail users along a particular route, and to direct and lead users to adjacent destinations (see figure 4.4). The Kansas City region recently adopted a new “Metro Trail” sign to be used to identify sections of trail that will help make up the new regional trail system. When utilizing directional signs it is important to give users specific information on destinations and distance.



**Figure 4.4**  
*Example of  
Trail Signing*

Source: Mid-America  
Regional Council.



Information signs enhance the quality of user experience on trail facilities. Signs that provide related information on the natural or social history of an area can encourage among users a greater appreciation of the characteristics of an area. Care should be taken to locate such signs—signs that encourage users to stop to read them—away from the actual trail travelway so as not to conflict with other trail users.

**SECURITY**

Multi-use paths in secluded areas should be designed with personal security in mind. Lighting and clear sight distances improve visibility. Location markers, mileage posts and directional signing help users know where they are. Frequent access points improve response time by emergency vehicles.

**MAINTENANCE**

Multi-use paths require regular inspection, sweeping, and repairs. They must be built to a standard that allows appropriate maintenance equipment to use the path without damaging it. A routine maintenance program is necessary to ensure bicyclist and pedestrian user safety and to prolong the life of a facility. Maintenance activities should be prioritized, with safety always being at the top of the list. Specific maintenance tasks performed will vary considerably according to allowed uses, surface and the facility's geographic location.





---

## Typical Maintenance Tasks for Off- Road Facilities

- ◆ Patching or regrading the trail surface on a regular basis.
- ◆ Inspecting and repairing or replacing signs, traffic markings, bollards and gates.
- ◆ Mowing shoulders and other areas.
- ◆ Trimming vegetation to meet sight-distance requirements.
- ◆ Removing fallen trees, limbs and debris.
- ◆ Repairing any damage from seasonal washouts.
- ◆ Cleaning culverts, catch basins and other drainage structures.
- ◆ Sweeping the trail to keep it free of debris.
- ◆ Removing snow and ice.
- ◆ Keeping lights clean and replacing fixtures as required.
- ◆ Maintaining support facilities such as benches and drinking fountains.
- ◆ Maintaining unique features such as bridges and tunnels.
- ◆ Inspecting trail-related structures to ensure that they are in good condition.
- ◆ Picking up litter and emptying trash cans.

Source: National Bicycle and Pedestrian Clearinghouse, *Technical Brief #6: Maintenance of Bicycle and Pedestrian Facilities*, Washington, DC, 1996.



## 5.1 COMPREHENSIVE PLANS

### SECTION 5

Comprehensive plans

Zoning provisions

Site plans and design review

Retrofitting existing areas to serve pedestrians

RETURN TO  
TABLE OF CONTENTS

---

### Items to Address in a Comprehensive Plan

To achieve the goal of creating a walkable community local government should fully integrate pedestrian considerations and provisions into ongoing planning activities (e.g., comprehensive planning, zoning regulations, site plan ordinances and review, street design standards). Effective pedestrian-oriented land-use and transportation systems planning will have a significant impact on pedestrian travel. The following items should be addressed as part of the comprehensive plan:

- ◆ The plan should include a clear statement of policy regarding pedestrian needs and objectives. It should make clear the desire of the community to ensure that people have the option of walking to many of their destinations. It should state that children should be able to walk to their schools and to nearby parks. It should declare that a walkable community is essential to having a healthy community.
- ◆ The plan should encourage a mix of land uses. Only by locating different but compatible activities such as residences, employment centers, schools, neighborhood shopping, and parks in close proximity to each other (and with adequate pedestrian facilities between them) can we expect people to make trips by walking.
- ◆ By providing for higher density development, a comprehensive plan will help increase access to a wider range of activities by walking.
- ◆ The plan should emphasize the development of neighborhood and community centers that are pedestrian-oriented rather than automobile-oriented.
- ◆ The plan should provide for the development of a grid pattern for roadways to provide for easy access for pedestrians and to help slow and disperse motor vehicle travel.<sup>41</sup>
- ◆ The plan should require the provision of pedestrian facilities in conjunction with virtually all kinds of development, and ensure that pedestrian ways are included so as to permit direct travel between origins and destinations.

<sup>41</sup> A study of a grid versus cul-de-sac system in Florida estimated 43 percent fewer motor vehicle miles traveled within the grid system. See Kulash, Walter, *Traditional Neighborhood Development: Will the Traffic Work?* (Real Estate Research Corporation, 1990).



- ◆ The plan should encourage the adoption of street design standards that give priority to safe, easy access for pedestrians in residential and commercial areas, as well as in areas near schools, parks, libraries, and other public places. Such things as design speed, number of lanes, overall roadway width, location and width of sidewalks, and intersection design should be appropriate to encourage walking.

## 5.2 ZONING PROVISIONS

As communities responded to growth pressures following World War II, new zoning codes were designed to separate different types of land uses. This approach was adopted by many cities and counties in response to citizen concerns about incompatible development near their homes. This approach to zoning has created auto-oriented towns throughout the country, including most in the Kansas City area. Zoning that is more pedestrian-oriented can create an environment where people feel comfortable getting out of their cars. The key is opportunity or choice. A mix of small zoning districts in a grid of pedestrian-scaled streets, together with attention to details of design of sites, buildings, and transportation facilities will help develop more walkable communities. Here are some of the automobile-oriented vs. pedestrian-oriented zoning contrasts:

**Segregated Use vs. Mixed Use.** In many communities, zoning has been based on the idea that work places, shopping, and even different kinds of housing must be segregated from one another. Planners create a number of very specific zoning categories for the various activities that make up a community, then divide the land into large zoning districts. This approach has effectively separated the activities in such a way as to limit opportunities for walking. Places where daily activities are intermixed, and where neighborhoods are active and unique, experience greater pedestrian activity.

**Automobile-Scaled Districts vs. Pedestrian-Scaled Districts.** Zoning districts are often mapped out in very large tracts bounded by wide, arterial highways. This tends to create great distances between housing, shopping, schools, and work places. By adopting an approach of using a variety of small zoning districts bounded by local streets, planners tend to naturally distribute the land uses that make up a community in a more pedestrian-scaled arrangement.

**Automobile-Only Circulation vs. Circulation for People.** Traditionally, zoning has simply set forth a specific type of land development while leaving the layout of the local street system-and the pedestrian circulation system-up to the various developers. The assumption has been that the zones will be connected by highways and that will take care of the transportation system needs. Clearly, this has not served the needs of pedestrians. A far better approach is to map the general layout of the local streets-the transportation “system” for pedestrians-when an area is zoned for commercial, residential, or mixed-use development. Local street alignments can latter be modified as actual development projects are planned. In this way, development proceeds according to a plan that accommodates people, not just cars.



**Designed Segregation vs. Designed Integration.** Typically, where two different zones come together, zoning provisions are too often concerned with land-use compatibility. Buffers may be required using walls, landscaping, or large setbacks when a grocery store is built near houses or an office building near an apartment building. Complicated formulas for determining required building setbacks, parking requirements, and lot coverage may work to frustrate efforts to develop more pedestrian-oriented developments. A better approach is to recognize that encouraging housing of a variety of densities, for instance, can be good for neighborhoods and that mixing in shops, offices, and parks can enhance the quality of a residential area. Attractive, pedestrian-scaled streets make natural transitions between users, while local design guidelines can help integrate different land uses through good design, rather than segregating land uses that are badly designed.

---

### Checklist of Pedestrian-Oriented Provisions for Zoning

- ◆ Use fewer, more general zoning categories to promote integration of different activities and to provide greater flexibility for developers.
- ◆ Use existing or planned local streets as boundaries for zoning districts to encourage a mix of activities at a walkable scale.
- ◆ Incorporate spots for neighborhood-oriented commercial development to encourage walking for errands in residential areas.
- ◆ Provide for higher density residential and mixed-use zones to foster neighborhood and village centers, especially along transit routes.
- ◆ Keep automobile-oriented commercial uses in specific zones located along main highways and arterials to reduce traffic congestion in neighborhoods and shopping areas.
- ◆ Require that streets, sidewalks, and walkways connect to adjacent properties, including properties not yet developed.
- ◆ Ensure that walking facilities are planned to provide pedestrians with the shortest/most direct possible route to nearby destinations.
- ◆ Provide for a high level of lot coverage for properties along transit routes to encourage intensification of uses.
- ◆ Modify parking requirements or reduce parking options for developments located along transit routes which provide facilities for walking and bicycling.
- ◆ Provide for a mix of uses within downtown buildings.
- ◆ Define streets according to adjacent land uses and by community objectives desired for the area, not simply serving motor vehicles.
- ◆ Encourage the use of a grid pattern network, especially in residential and commercial areas.



---

Recommendations for pedestrian-friendly zoning provisions related to six specific kinds of areas<sup>42</sup>

**Recommendations for Zoning Residential Areas — Low/Medium Density**

1. Residential Areas - Low/Medium Density
2. Residential Areas - High Density
3. Commercial Areas
4. Office/Industrial Areas
5. Planned/Traditional Neighborhood Developments
6. Transit Zones

When people can walk to a nearby store, park, school, or even to work, traffic is reduced and the livability of the neighborhood improves. Mixed housing types help make a neighborhood more vibrant and diverse.

- ◆ Allow neighborhood stores, day care, small office buildings, schools, parks, and community-oriented institutions.
- ◆ Allow second-story apartments or offices in neighborhood commercial buildings.
- ◆ Allow a wide variety of home occupations.
- ◆ Allow duplexes, accessory dwellings, zero-lot-line, wide-and-shallow lots, and other innovative designs that increase housing variety.
- ◆ Require a neighborhood park or other public focal point in subdivisions of 30 or more lots.
- ◆ Encourage developments of more than 9 dwellings per acre within 1/4 mile of transit stops on major collectors and arterials.
- ◆ Encourage clustering of lots to allow for amenities such as parks and open space.
- ◆ Require sidewalks on both sides of all streets.
- ◆ Encourage a grid pattern for streets with small blocks (i.e., 300 feet or less).
- ◆ Encourage alleys and rear-of-lot garages.
- ◆ Prohibit cul-de-sacs unless terrain or existing road patterns require them. If cul-de-sacs are used, require walkways to connect them directly to adjacent streets and sidewalks.
- ◆ Discourage gated access to and perimeter walls around subdivisions.
- ◆ Require pedestrian breaks at 50-foot intervals where a wall, ditch, or landscaped area separates a sidewalk from a building or one development from another.
- ◆ Require direct walkways between neighborhoods and any nearby shops, parks, schools, libraries, and transit stops.
- ◆ Require narrow residential streets.

<sup>42</sup>Based on Sno-Tran, *Creating Transportation Choices Through Zoning* (1994).



**Recommendations  
for Zoning  
Residential Areas —  
High Density**

- ◆ Require regularly spaced street trees.
- ◆ Require no more than one off-street parking space per dwelling.
- ◆ Allow on-street parking.

Commercial services, small-scale offices, schools, and parks complement medium to higher density housing. Mixing these uses can make neighborhoods lively and keep them more secure while giving large numbers of people easy access to work, shops, and other daily destinations. Parks and public spaces are especially important to making higher density neighborhoods attractive and enjoyable.

- ◆ Permit neighborhood-oriented commercial uses in apartment and condominium projects.
- ◆ Encourage neighborhood stores, offices and restaurants in apartment and condominium buildings.
- ◆ Allow office buildings, if compatible in scale and design.
- ◆ Encourage community facilities such as day care, schools, and libraries.
- ◆ Require a small neighborhood park, square, or other public space in developments with 30 or more dwellings.
- ◆ Discourage automobile-oriented users such as drive-throughs, auto sales, and large retail outlets.
- ◆ Limit the number of parking spaces.
- ◆ Encourage affordable housing and senior housing within 500 feet of bus stops and transit facilities.
- ◆ Discourage buildings less than two stories high in medium density zones.
- ◆ Discourage projects of less than 20 dwelling units per acre within 500 feet of bus stops and transit facilities.
- ◆ Require sidewalks (a minimum of 8 feet wide) on both sides of every street.
- ◆ Require connected streets that form pedestrian-scale blocks (300 feet or less on a side).
- ◆ Prohibit cul-de-sacs and dead end streets except where terrain or existing conditions require them.
- ◆ If cul-de-sacs are necessary, require walkways connecting them to any adjacent streets.
- ◆ Encourage alleys for access to rear-of-lot parking lots or garages.
- ◆ Require each development project to be connected to adjacent developments via a direct (shortest possible route between buildings) sidewalk or walkway.



- ◆ Discourage perimeter walls around development projects.
- ◆ Require direct pedestrian access between housing and any adjacent transit facility.
- ◆ Require pedestrian breaks and/or crossings at a minimum of 5-foot intervals where a wall, ditch, or landscaped area separates a sidewalk from a building entrance or one development from another.
- ◆ Require narrow local streets.
- ◆ Require minimal building setbacks (10 feet or less from the sidewalk).
- ◆ Require that buildings face and have entrances near the street.
- ◆ Require that parking areas or garages be located to the rear or sides of buildings.
- ◆ Require regularly spaced street trees.
- ◆ Encourage awnings or overhangs that protect the sidewalk from weather.
- ◆ Require a minimum amount of parking.
- ◆ Allow on-street parking.
- ◆ Encourage shared parking arrangements between residential and commercial uses.
- ◆ Encourage locating parking within or beneath buildings.

**Recommendations for  
Zoning Commercial Areas**

Mixing offices with retail services and shopping allows people to take care of many daily errands without needing a car. Commercial areas interspersed with housing fills a niche in the housing market while helping to keep these areas more lively and secure. By placing a variety of complementary uses within walking distance of one another-and ensuring that they are linked by safe, direct walkways-a community promotes walking.

- ◆ Encourage a mix of offices and retail shops within buildings or development sites.
- ◆ Encourage housing on upper floors of commercial buildings.
- ◆ Require that adjacent developments be connected via safe, direct walkways.
- ◆ Require public spaces such as small parks, squares, or sitting areas as part of commercial or mixed-use projects.
- ◆ Allow apartment buildings and condominiums of compatible scale and design.
- ◆ Encourage commercial shops and services adjacent to transit stops and park-and-ride lots.



- ◆ Discourage buildings less than two stories high.
- ◆ Encourage developments with a floor area ratio of 1.0 or higher.
- ◆ Encourage developments with 50 or more employees per acre.
- ◆ Prohibit subdivision of land into lots for single family developments.
- ◆ Require sidewalks (a minimum of 8 feet wide) on both sides of every street.
- ◆ Require connected streets that form pedestrian-scale blocks (300 feet or less on a side).
- ◆ Prohibit cul-de-sacs and dead end streets except where terrain or existing conditions require them.
- ◆ If cul-de-sacs are necessary, require walkways connecting them to any adjacent streets.
- ◆ Encourage alleys for access to rear-of-lot parking lots or garages.
- ◆ Require each development project to be connected to adjacent developments via a direct (shortest possible route between buildings) sidewalk or walkway.
- ◆ Require arcades that give the pedestrian a shortcut through buildings 300 feet long or longer.
- ◆ Discourage walls separating commercial developments from adjacent neighborhoods.
- ◆ Require direct pedestrian access between housing and any adjacent transit facility.
- ◆ Require pedestrian breaks and/or crossings at a minimum of 50-foot intervals where a wall, ditch, or landscaped area separates a sidewalk from a building entrance or one development from another.
- ◆ Limit street width to discourage higher speed traffic.
- ◆ Require minimal building setbacks (20 feet or less from the sidewalk).
- ◆ Require that buildings face and have entrances near the street (preferably the local street rather than an arterial).
- ◆ Encourage buildings with large windows and outdoor sitting places at the street level.
- ◆ Require that parking areas or garages be located to the rear or sides of buildings.
- ◆ Require regularly spaced street trees.
- ◆ Encourage awnings or overhangs that protect the sidewalk from weather.





- ◆ Do not require a minimum amount of parking.
- ◆ Allow on-street parking.
- ◆ Require large parking lots to be broken up into blocks no more than 300 feet on a side, complete with curb, sidewalk, and street trees.
- ◆ Encourage shared parking arrangements between residential and commercial uses.
- ◆ Encourage first-floor retail shops on the street sides of parking garages.
- ◆ Require bicycle parking near the front entrance of commercial buildings.

**Recommendations for Zoning  
Office / Industrial Areas**

When commercial services such as banks, laundries, day care, and restaurants are located near offices and industries, employees can take care of daily errands without needing a car. When a car isn't needed, it becomes possible to carpool, take the bus, or even bicycle or walk to work. In many cases, housing can be integrated within office and light industry areas, helping to create a local balance between jobs and housing, thus reducing commuter traffic. The new Sprint campus in southern Overland Park provides commercial services for the expected 14,000 employees on the site.

- ◆ Encourage retail stores and commercial services in industrial and office zones.
- ◆ In business parks, encourage a centrally located core of shops, restaurants, and services.
- ◆ Encourage parks, public squares, and recreational facilities within office and industrial sites.
- ◆ Allow park-and-ride lots and transit centers.
- ◆ Require direct walkways connecting office and industrial developments to adjacent neighborhoods.
- ◆ Require no more than 15 percent of a site to be landscaped.
- ◆ Encourage developments with a floor area ratio of 1.25 or higher.
- ◆ Encourage developments with 50 or more employees per gross acre.
- ◆ Discourage single-story buildings.
- ◆ Require sidewalks (a minimum of 6 feet wide) on both sides of every street.
- ◆ Require connected streets that form pedestrian-scale blocks (300 feet or less on a side).
- ◆ Prohibit cul-de-sacs and dead end streets except where terrain or existing conditions require them.



- ◆ Require that truck loading areas and outdoor storage be located to the rear of buildings and out of pedestrian pathways, to the extent feasible.
- ◆ Require each building or development to be connected to adjacent buildings or developments via direct walkways.
- ◆ Discourage walls separating commercial developments from adjacent neighborhoods.
- ◆ Require direct pedestrian access between housing and any adjacent transit facility.
- ◆ Require pedestrian breaks and/or crossings at a minimum of 50-foot intervals where a wall, ditch, or landscaped area separates a sidewalk from a building entrance or one development from another.
- ◆ Encourage narrow streets.
- ◆ In higher density areas, require narrowed crossings at intersections.
- ◆ Require minimal building setbacks (20 feet or less from the sidewalk).
- ◆ Require that buildings face and have entrances near the street (preferably the local street rather than an arterial).
- ◆ Encourage buildings with large windows and attractive architectural details facing the street.
- ◆ Require regularly spaced street trees.
- ◆ Encourage awnings or overhangs that protect the sidewalk from weather.
- ◆ Encourage public sitting areas with benches and landscaping at the front of buildings.
- ◆ Require outdoor lighting along sidewalks and walkways.
- ◆ Encourage pedestrian shortcuts through buildings over 300 feet long.
- ◆ Require that parking areas or garages be located to the rear or sides of buildings.
- ◆ Allow on-street parking. (If a minimum parking requirement is imposed, allow on-street parking to count toward the requirement.)
- ◆ Require large parking lots to be broken up into blocks no more than 300 feet on a side, complete with curb, sidewalk, and street trees.
- ◆ Encourage shared parking arrangements where neighboring activities have different peak-use periods.
- ◆ Require bicycle parking near the front entrance of commercial or industrial buildings.



**Recommendations  
for Zoning Planned/  
Traditional  
Neighborhood  
Developments**

For Planned or Traditional Neighborhood Developments to work as a small community, they must contain not only housing, but places to shop and work, as well as parks, schools, and other public services. Locating these uses within easy walking distance of one another, in a carefully planned, pedestrian-scale pattern, encourages people to walk and bicycle and makes the community more livable. A mix of housing, businesses, and recreation allows residents to accomplish many of their daily activities without driving.

- ◆ Require a centrally located community gathering place that includes a public square or park.
- ◆ Encourage retail stores and professional services in or adjacent to the community center.
- ◆ Allow housing on upper floors of commercial buildings in the town center area.
- ◆ Encourage neighborhood-oriented retailing and professional services near neighborhoods.
- ◆ Require that all dwellings be located within 1,000 feet of a park or greenway.
- ◆ Encourage schools and other civic uses.
- ◆ Allow a variety of housing types, including apartments and condominiums, townhouses, accessory dwellings, and houses on small lots.
- ◆ Encourage park-and-ride lots and transit centers.
- ◆ Discourage single-use tracts of 5 acres or larger.
- ◆ In primarily residential areas, encourage residential densities of at least 7 dwellings per acre.
- ◆ In commercial centers and nodes, encourage commercial and mixed-use buildings of at least two stories.
- ◆ Require sidewalks on both sides of every street.
- ◆ Require connected streets that form pedestrian-scale blocks (300 feet or less on a side).
- ◆ Encourage alleys and rear-of-lot garages.
- ◆ Prohibit cul-de-sacs and dead-end streets except where terrain or existing conditions require them.
- ◆ If cul-de-sacs are used, require walkways that connect them to adjacent streets and sidewalks.
- ◆ Discourage perimeter walls around and gated access to the development.
- ◆ Require direct walkways between neighborhoods and nearby parks, stores, schools, and transit facilities.



- ◆ Require pedestrian breaks and/or crossings at a minimum of 200-foot intervals where a wall, ditch, or landscaped area separates neighborhoods or different uses within a development or separates the development from adjacent areas.
- ◆ Discourage tracts of a single type of housing or commercial development greater than 10 acres in size.
- ◆ Require a streetscape plan that ensures regularly spaced streets, lighting, and pedestrian amenities.
- ◆ Encourage narrow streets, with on-street parking.
- ◆ Require minimal or no building setbacks.
- ◆ Require that commercial buildings, apartments, condominiums, and public buildings have entrances close to and facing the street.
- ◆ Encourage buildings with large windows and attractive architectural details facing the street.
- ◆ Encourage public sitting areas with benches and landscaping at the front of buildings.
- ◆ Discourage parking lots with more than 30 stalls from abutting a street.

**Recommendations for  
Zoning Transit Zones**

Transit Zones are used in many parts of the country to better match land use and transportation investments. They are used to create a denser and more walkable environment around transit facilities. Typically, such a zone is about 1/4 mile in diameter and centered on the transit center. With a mix of housing, offices, shops, and services, a transit zone will have more people coming and going-and making use of transit services-throughout the day. People who live within walking distance of the zone will have work, shopping, and recreation opportunities available not only within the zone itself, but within other centers and hubs linked by the transit system. And people arriving by transit will find a variety of destinations nearby, making it possible to leave their cars at home.

- ◆ Encourage a variety of housing types, including apartments, condominiums, townhouses, duplexes, and accessory dwellings.
- ◆ Allow retail stores and services, offices, schools, civic and recreational uses.
- ◆ Encourage retail shops on the ground floor of apartment and condominium buildings.
- ◆ Prohibit automobile-oriented uses such as auto sales and repair, commercial parking lots, and drive-through businesses.
- ◆ Discourage supermarkets, hardware stores, or wholesale outlets with over 50,000 square feet of floor area.
- ◆ Prohibit residential developments of under 20 dwelling units per acre.



- ◆ Discourage buildings less than two stories high.
- ◆ Require that new offices and mixed-use developments have a floor area ratio of 1.25 or greater.
- ◆ Require sidewalks (a minimum of 10 feet wide) on both sides of every street.
- ◆ Require that developments foster a network of connected streets that form small blocks (200 to 300 feet on a side).
- ◆ Prohibit cul-de-sacs and dead-end streets except where existing conditions require them.
- ◆ If cul-de-sacs are used, require walkways that connect them to adjacent streets and sidewalks.
- ◆ Require short, direct walkways from door to door between adjacent development projects and from building entrances to adjacent transit stops.
- ◆ Discourage walls and fences that lengthen the walking distance between one site and another.
- ◆ Require direct walkways between neighborhoods and nearby parks, stores, schools, and transit facilities.
- ◆ Require pedestrian breaks and/or crossings at a minimum of 50-foot intervals where a wall, ditch, or landscaped area separates a sidewalk from a building entrance or one development from another.
- ◆ Encourage narrow streets, with on-street parking.
- ◆ Require buildings to be sited no more than 10 feet back from the sidewalk.
- ◆ Require buildings to face and have entrances on the sidewalk.
- ◆ Require regularly spaced street trees.
- ◆ Encourage large windows and protective awnings or overhangs on building facades that face sidewalks.
- ◆ Encourage public sitting areas with benches and landscaping along building fronts, and pedestrian-scale street lighting.
- ◆ Minimize parking requirements.
- ◆ Discourage residential developers from providing more than one off-street parking space per dwelling.
- ◆ Discourage office developers from providing more than one parking space per 600 square feet of building floor area.
- ◆ Allow on-street parking.
- ◆ Encourage “pocket lots” of 30 or less spaces interspersed with landscaping and buildings.



## 5.3 SITE PLANS AND DESIGN REVIEW

- ◆ Encourage parking within or beneath buildings.
- ◆ Encourage shared parking arrangements between residential and commercial areas.

A pedestrian-sensitive site plan is one in which the pedestrian is recognized as a significant factor in shaping the arrangement of facilities and the relationship of those facilities to others nearby. The key to creating walkable communities is to ensure that every site plan considers and addresses the needs of pedestrians from the beginning—not ignoring them or treating them as an afterthought—and follows through by creating a truly pedestrian-friendly site.

In general, local planning ordinances and local street design standards and specifications should clearly state the guidelines for sidewalk installation, including funding and maintenance responsibility.

### DESIGN OBJECTIVES FOR PEDESTRIAN- FRIENDLY SITE PLANS

The following factors or design objectives are essential ingredients of a pedestrian-sensitive site plan. They should be incorporated into site planning ordinances, provided to developers at the earliest possible stage in their planning, and used by local governments in their review of proposed site plans.

---

### Design Objectives

- ◆ A continuous pedestrian network, connecting pedestrian origins and destinations with sidewalks and walkways that are direct and barrier-free.
- ◆ Minimum number of conflict points between pedestrians and motor vehicles.
- ◆ Minimum impedance to the pedestrian in terms of amount of time, distance, or energy expenditure.
- ◆ Clear delineation of pedestrian walkways to assure that effective walking routes can be selected.
- ◆ Pedestrian facilities designed for ease of maintenance.
- ◆ Provision of amenities (e.g., landscaping, trees, benches) to enhance the walking experience.
- ◆ Consideration of special pedestrian needs (e.g., ADA, children, seniors).
- ◆ Facilities designed to maximize pedestrian security, such as good lighting and clear sight lines.



Unfortunately, there are many past and current examples of where site planning has failed to adequately consider the needs of pedestrians. The reasons typically include lack of concern for or recognition of pedestrian needs; lack of established policies or procedures for requiring and evaluating planned pedestrian facilities during site plan review; the economics of site development priorities and market competition; the fragmented ownership of land parcels and jurisdictional responsibilities over the development of these parcels; variations in design standards for development projects; the difficulties in demonstrating the cost-effectiveness of pedestrian-facilities; overriding interests in promoting development at the expense of good design; a long-standing, automobile-oriented approach to access; and the difficulties faced by public agencies in rapidly developing areas in coping with the scale and rate of new development.

**GENERAL PRINCIPLES  
IN SITE PLANNING  
FOR PEDESTRIANS**

---

General Principles

Improving the site planning process for pedestrians requires that attention be given right from the beginning and throughout the process to the needs of pedestrians, and not merely as an afterthought. The basic principles listed below will help to create pedestrian-friendly site plans.

**Establish initial concepts for the site development program.** Ensure that pedestrians and walking are explicitly recognized as factors to be addressed in the development of the site.

**Inventory the site.** Conduct a walking inventory of the prospective site to help identify features and elements that constitute both opportunities and challenges for pedestrians.

**Map adjacent site pedestrian “magnets.”** Existing and planned walking “attractors” or “generators” within 1/2 mile of the site should be mapped. In addition, the existing pedestrian facilities network should be mapped. This will help to establish the general routes the on-site pedestrian network should serve as well as the points along the perimeter where connections should be planned. The points should provide for linkages that are direct.

**Locate opportunities for “recreational” walkways.** Identify the most probable locations for greenway-type walkways, independent of street and highway rights-of-way. These can include general open space, stream valleys, and utility easements. A check should be made to see if there are opportunities to connect to the Metro Trail network.

**Sketch out more detailed site planning options.** This is perhaps best accomplished by considering proposed building locations, types of land use, locations and type of parking facilities, locations of driveways, street pattern and proposed function and design, and basic pedestrian facilities. This step will help identify potential conflicts among uses, users, and functions.



**Identify logical street crossings and incorporate requirements into appropriate street/intersection design.** This should include needed mid-block crossings.

**Consider the frequency and volume of pedestrian trips.** This will help determine design parameters such as sidewalk width and street lighting.

**Identify potential conflicts with motor vehicles and develop effective treatments.** The planned traffic patterns and facilities need to be analyzed from the standpoint of the potential for conflicts with pedestrians. In each case, the design of streets and highways—including intersections, driveways, and parking areas—should be adjusted to ensure safe and easy movement for pedestrians.

In addition to these principles, a number of specific considerations should be made in the review of site planning, roadway improvement and other development documents:

---

Checklist for  
Pedestrian-Oriented  
Site Plan  
and Highway

Design Review  
Building Arrangements  
and Land Use Types

Overall Pedestrian System

- ◆ Has consideration been given to keeping walking distances between buildings to a minimum? Can walking distances to nearby sites be shortened?
- ◆ Does the density and mix of land uses foster walkability, given both the opportunities and constraints provided for by applicable zoning requirements?
- ◆ Will the building arrangements require pedestrians to take awkward paths through parking lots?
- ◆ Are building entrances located and designed to be obvious and easily accessible to pedestrians?
- ◆ Has future development within and adjacent to the site been considered and addressed in terms of walkability?
- ◆ Are both utilitarian walking and opportunities for recreational walking considered and appropriately addressed?
- ◆ Are utilitarian walkways direct? Do they provide for connections to existing pedestrian magnets nearby?
- ◆ Do recreational walkways take advantage of unique site features?
- ◆ Is there easy walking access to and from residential areas? Are mid-block crossings and walkways and connections at the end of cul-de-sacs provided?
- ◆ Does the pedestrian system consider the type and probable location of future development on adjacent or nearby parcels of land? Is there the flexibility to provide direct connections to adjacent parcels?
- ◆ Are parking lots located so as not to conflict with easy, safe pedestrian travel? Are parking lots designed to accommodate safe travel by pedestrians?





- ◆ Are pedestrian connections and entrances clearly evident, through either design features, topography, signing or markings?
- ◆ Are schools, parks, libraries, post offices, and the community sites easily and safely accessible for all likely users (e.g., children)?
- ◆ Are openings through walls, fences, and hedges provided for pedestrian access?
- ◆ Is landscaping designed both to enhance conditions for pedestrians and so as not to compromise safety and security (e.g., by limiting sight distance at driveway entrances)?
- ◆ Are there direct and pleasant walking routes to nearby transit stops?
- ◆ Are walkways generally visible from nearby buildings and free from dark, narrow passageways?
- ◆ Is adequate lighting provided for nighttime security?
- ◆ Do walkways lead to safe and direct crossing points?
- ◆ Are sidewalks and walkways designed to approved standards and do they conform to ADA requirements?
- ◆ Are walkway surfaces skid-resistant and are slopes within prescribed guidelines?
- ◆ Are corners and curb ramps appropriately planned and designed?
- ◆ Are street and highway crossings-both at intersections and mid-block locations-designed to provide safe and easy access for pedestrians?
- ◆ Is the number of driveways kept to a minimum? Are driveway locations appropriate (e.g., at school sites)? Are parking lot and other driveway entrances properly designed and landscaped?
- ◆ Are amenities included and appropriately located and designed so as to enhance conditions for pedestrians?

**Walking Facilities  
and Amenities**

**Highway Design  
and Traffic Operations**

- ◆ Are pedestrian/vehicle conflict points kept to a minimum?
- ◆ Are pedestrians clearly visible to traffic at pedestrian crossing locations?
- ◆ Are pedestrians given priority at appropriate locations?
- ◆ Is street width for local residential streets and appropriate commercial streets kept to a minimum?
- ◆ Are streets and highways designed to keep motor vehicle speeds at levels compatible with pedestrian activity? Are traffic-calming techniques used to help ensure that motor vehicles are not operated in excess of appropriate speeds?
- ◆ Are curb radii kept to the minimum necessary to keep pedestrian crossing distances short, and to reduce the speed of turning motor vehicles?



- ◆ Are intersection designs simple?
- ◆ Are medians and refuge islands provided where pedestrians must cross four or more lanes of traffic?
- ◆ Are walkways along the street separated and buffered from traffic as much as possible?
- ◆ Are crosswalks marked and are other traffic control devices used to help ensure the motor vehicles stop for pedestrians?
- ◆ Are lights provided directly over pedestrian crossing locations?
- ◆ Have pedestrian crossings at interchanges been considered and provided for?
- ◆ Have the potential problems of pedestrians crossing at traffic signals been adequately addressed? Will the phasing and timing confuse or appropriately accommodate pedestrians?
- ◆ Have pedestrian routes through construction areas been planned for?
- ◆ Are transit stops designed to be easily accessible and are appropriate amenities provided?

## 5.4 RETROFITTING EXISTING AREAS TO SERVE PEDESTRIANS

**A**lthough considerable new development is and will continue to occur throughout metropolitan Kansas City, the vast majority of our community is now developed. Our local communities have tremendous opportunities to encourage reinvestment in existing neighborhoods and commercial areas that results in greater pedestrian activity. Personal health and the health of our communities may well depend on making sure people can and do walk regularly. Walkable communities are livable communities and real estate trends are increasingly showing that people want to live in “livable” neighborhoods.

So, what can we do to fix the communities we already have, to make them less automobile-oriented and more walkable? This section offers some suggestions for approaches to retrofitting existing developed areas to better serve the needs of pedestrians.

### SUBURBAN RESIDENTIAL NEIGHBORHOODS

The generally quiet neighborhoods of thirty and forty years ago have been overrun by automobiles. What started off as a subdivision with a car in the driveway of each home now has changed to two, three, and four cars per household. The streets where motorists once drove carefully, slowing for neighborhood children whom they likely knew, are now filled with speeding motor vehicles whose operators drive 45 mph



and pass inches from kids waiting for a school bus. There aren't any sidewalks, and in many cases, the shortest route to most destinations such as schools and shopping isn't short at all. We've separated different kinds of land use to the point that virtually every trip is now made by car.

The good news is that across America communities are turning this situation around. Here are some of the things that can-and should-be done:

◆ **Shorten the distance.**

Encouraging neighborhoods with a mix of land uses and a better “connected” network of walking routes is the right place to start. Opportunities within existing neighborhoods to create pedestrian destinations include restoring and reusing a neighborhood school that has been closed. Or, it could be changing the zoning to permit the development of small, neighborhood shopping areas. Developing vacant sites as “pocket” parks or playgrounds provides shorter distances for residents, particularly children, to go for recreation.

Often, post-war suburban subdivisions were laid out with a pattern of streets that requires long, circuitous journeys to get from point A to point B, whereas the sites are actually quite close together. Older urban and small town neighborhoods have grid street patterns that provide for both shorter, more direct travel and more route choices. This actually improves access for motorists and pedestrians. The challenge is to “re-engineer” the suburban street network. One way to do this, for both pedestrians and bicyclists, is to acquire and develop easements between existing properties that provide better connections within the community. Convincing existing residents to allow access alongside their property to provide for these connections can be difficult. However, because of their neighborhood character and the overall scale of these kinds of improvements, that quickly blend into the community and prove to be compatible with adjacent homes and businesses.

◆ **Increase the density of development.**

Where vacant tracts exist, medium density housing should be encouraged, possibly in conjunction with neighborhood retail businesses and services (e.g., day care). Similarly, where lot sizes will accommodate them, consideration should be given to permitting the development of accessory apartments. These changes are intended to increase residential densities and thus the likelihood that the neighborhood can support services such as schools, neighborhood retail and service centers, and transit.

◆ **Provide people with good places to walk.**

Earlier in this report it was established that in most places, sidewalks should be provided on both sides of virtually every street, especially in residential areas. But, what do you do in the case of retrofitting existing, long-established neighborhoods? These are places where tree and hedges have been planted, fences have been built, and cars



are frequently parked on the verge. Where the street is no more than two lanes and the speed no more than 30 mph the answer may be to direct efforts towards installing a sidewalk along one side of the road. Then, the challenge becomes one of determining which side it will be. Predictably, property owners on each side will provide good arguments for why the sidewalk should be on the other side.

In addition to putting sidewalk facilities in place, it is important to improve street crossings (see Section 3) and to make the places people walk attractive. This entails providing things such as shade trees, lighting, and benches at appropriate locations. And, it means keeping sidewalks well-maintained and free from encroachment from shrubs and conflicting uses like parked cars and newspaper boxes.

◆ **Slow the motor vehicle traffic.**

One of the biggest changes in our neighborhoods over the past thirty years or so is that people are driving much faster on the same streets. And they typically don't slow down for anything including children walking along the street. While various explanations are put forward to explain this phenomenon, the fact remains that people are driving too fast for conditions and discouraging or endangering pedestrians. Increasingly, neighborhood residents are demanding that something be done. Enforcement, while effective and necessary, is typically expensive and can't always be done everywhere it is needed as a deterrent. The answer is to re-engineer the streets to contain and control motor vehicle speeds to levels appropriate to, and compatible with, the activities that take place there.

Traffic-calming techniques (see Section 3) are proving very effective in reducing motor vehicle speeds and cut-through traffic (as motorists look for short-cuts to avoid congested roadways). Narrower lane widths, speed humps, roundabouts, and traffic diverters are just some of the design treatments that are being used to make it safe again for people to walk and for children to play in their neighborhood.

**DOWNTOWNS AND  
MAIN STREETS**

For years, the downtowns and main streets of our towns and cities have suffered from neglect. Shopping moved to the malls and endless miles of strip commercial development. In many downtown areas, traffic patterns were changed to encourage greater motor vehicles speeds by converting two two-way streets to one-way pairs. Many communities have grown up without an identifiable "center." Now, however, the trend seems to be changing.

Communities are working to revitalize their downtown areas and main streets, to reclaim the investment in public and private infrastructure and make it an attractive, productive economic center again. A key element in the success of such efforts is the accommodation of pedestrian traffic. Indeed, the most successful of these efforts recognize that giving priority to pedestrians is the key to successful restoration and economic recovery. Here's what they are doing:



◆ **Provide high-quality facilities and amenities for pedestrians.** Wide sidewalks should be provided. In some cases, it may be necessary or desirable to widen the existing walkways. Enhancements such as textured pavement, awnings, pedestrian-scale lighting and signage, benches, public art, and shade trees and landscaping encourage people to come and to shop. Intersections should be redesigned to make it safe and easy for pedestrians to cross the street. On-street parking can serve as an additional buffer between the sidewalk and adjacent traffic.

◆ **Slow motor vehicle traffic.**

Downtowns and main streets are intended to serve as commercial, employment, and recreation areas. Fast motor vehicle traffic is contrary to these activities and should be prohibited. Two-way streets and on-street parking help, as do various traffic-calming techniques. Intersections should have curb bulbouts and, if they are wide, medians. Boulevard treatments can do much to mitigate the negative impacts associated with highway facilities. Marked crosswalks should be provided at every intersection and at mid-block locations where pedestrians can be expected to want to cross the street. Consideration should be given to using raised crosswalks and intersections. Curb radii should be kept as small as possible while accommodating slow-speed turns by transit vehicles and trucks. Right-turn-on-red should be prohibited at high-pedestrian volume locations, and there should be no use of free-flowing right turn lanes in downtown and main street areas. Strict enforcement should be used to help ensure that motor vehicle operators do not endanger pedestrians.

◆ **Promote pedestrian-friendly development.**

A great deal of research has been done to determine the kind of downtown and main street development and site design practices that promote pedestrian activity and produce economic success. The National Main Street Center has an extensive catalog of excellent guidelines and other materials.<sup>43</sup> The list of design treatments includes the following:

- Buildings should be located near the street, not set back behind parking areas.
- Parking lots should be located behind or beneath buildings, or in parking garages, and parking garages should have retail and/or residential space at street level and on the sides facing the street.
- Ideally, buildings along the street should be two stories or more.
- Store and office fronts should be redesigned to appeal to pedestrians with windows and awnings, and long expanses of blank wall should be prohibited.

<sup>43</sup>Contact the National Main Street Center, National Trust for Historic Preservation, 1785 Massachusetts Avenue, NW, Washington, DC 20036.

- Mixed uses in buildings should be permitted and encouraged (e.g., apartments located over street-level retail shops).
- Retail/commercial activities should be encouraged to interact with pedestrian space, with awnings, café seating, and planters, while ensuring that adequate space is kept free to accommodate easy, safe pedestrian travel.

Some of these proposals will likely require changes in local zoning regulations to permit and/or require the desired actions.

## RETAIL AND OFFICE DEVELOPMENTS

For pedestrians, getting to, through, and between employment centers, shopping malls and commercial strip developments is too often nearly impossible. The lack of access control along arterial streets has resulted in many dangerous driveway intersections. Frequently, sidewalks have not been provided. And, where sidewalks do exist along the roadway, there is typically no safe and easy way to get from the sidewalk across a sea of parked and moving cars to the building entrances. Finally, there is almost never an easy connection of any kind between adjacent commercial sites. Fortunately, many of these kinds of developments are being redeveloped, providing an opportunity to make changes to make these sites more pedestrian-friendly. Here are some of the things that can be done:

- **Implement access control.** Often, the purpose and function of arterial streets is seriously degraded and many crashes occur because there are too many driveway entrances along the roadway. This condition is also very hazardous to pedestrians. Consideration should be given to adopting access control guidelines.<sup>44</sup> These guidelines allow for multiple destinations to be served by a single entrance. Also, entrances should be designed to provide for safe and easy crossing by pedestrians and should conform to ADA requirements.
- **Improve the layout of building and parking lots.** These types of automobile-oriented developments can and should be made more pedestrian-friendly; fortunately, there are approaches that provide economic incentives to the property owners to make the improvements. Increase the permitted density of existing sites to encourage the addition of new retail buildings in the existing parking lot, directly fronting on the primary roadways. Locate parking to the sides and back of buildings. Look for opportunities to encourage shared use of parking areas to reduce the need for parking spaces.
- **Improve on-site and between-site access for pedestrians.** Improve the frontage streetscaping and coordinate with convenient transit access. Redesign building entrances to orient them to the street and pedestrian access. Provide

<sup>44</sup>Planning Commissioners Journal, May 1998.



covered walkways around and between buildings, if possible. Provide attractive and direct pedestrian connections between adjacent commercial developments. Develop new guidelines for the layout of parking areas to ensure safe, easy, and attractive access for pedestrians. Develop direct, safe, and easy access to sites from nearby residential areas.



# Walkability Checklist

## How walkable is your community?

### Take a walk with a child and decide for yourselves.

Everyone benefits from walking. These benefits include: improved fitness, cleaner air, reduced risks of certain health problems, and a greater sense of community. But walking needs to be safe and easy. Take a walk with your child and use this checklist to decide if your neighborhood is a friendly place to walk. Take heart if you find problems, there are ways you can make things better.

### Getting started:

First, you'll need to pick a place to walk, like the route to school, a friend's house or just somewhere fun to go. The second step involves the checklist. Read over the checklist before you go, and as you walk, note the locations of things you would like to change. At the end of your walk, give each question a rating. Then add up the numbers to see how you rated your walk overall. After you've rated your walk and identified any problem areas, the next step is to figure out what you can do to improve your community's score. You'll find both immediate answers and long-term solutions under "Improving Your Community's Score..." on the third page.





Take a walk and use this checklist to rate your neighborhood's walkability.

# How walkable is your community?

## Location of walk

## Rating Scale:



### 1. Did you have room to walk?

- Yes     Some problems:
- Sidewalks or paths started and stopped
  - Sidewalks were broken or cracked
  - Sidewalks were blocked with poles, signs, shrubbery, dumpsters, etc.
  - No sidewalks, paths, or shoulders
  - Too much traffic
  - Something else \_\_\_\_\_

**Rating:** (circle one)      Locations of problems:  
1 2 3 4 5 6      \_\_\_\_\_

### 4. Was it easy to follow safety rules? Could you and your child...

- Yes     No    Cross at crosswalks or where you could see and be seen by drivers?
- Yes     No    Stop and look left, right and then left again before crossing streets?
- Yes     No    Walk on sidewalks or shoulders facing traffic where there were no sidewalks?
- Yes     No    Cross with the light?

**Rating:** (circle one)      Locations of problems:  
1 2 3 4 5 6      \_\_\_\_\_

### 2. Was it easy to cross streets?

- Yes     Some problems:
- Road was too wide
  - Traffic signals made us wait too long or did not give us enough time to cross
  - Needed striped crosswalks or traffic signals
  - Parked cars blocked our view of traffic
  - Trees or plants blocked our view of traffic
  - Needed curb ramps or ramps needed repair
  - Something else \_\_\_\_\_

**Rating:** (circle one)      Locations of problems:  
1 2 3 4 5 6      \_\_\_\_\_

### 5. Was your walk pleasant?

- Yes     Some problems:
- Needed more grass, flowers, or trees
  - Scary dogs
  - Scary people
  - Not well lighted
  - Dirty, lots of litter or trash
  - Dirty air due to automobile exhaust
  - Something else \_\_\_\_\_

**Rating:** (circle one)      Locations of problems:  
1 2 3 4 5 6      \_\_\_\_\_

### 3. Did drivers behave well?

- Yes     Some problems: Drivers ...
- Backed out of driveways without looking
  - Did not yield to people crossing the street
  - Turned into people crossing the street
  - Drove too fast
  - Sped up to make it through traffic lights or drove through traffic lights?
  - Something else \_\_\_\_\_

**Rating:** (circle one)      Locations of problems:  
1 2 3 4 5 6      \_\_\_\_\_

## How does your neighborhood stack up? Add up your ratings and decide.

- |                     |              |   |
|---------------------|--------------|---|
| 1. _____            | <b>26-30</b> | Celebrate! You have a great neighborhood for walking. |
| 2. _____            | <b>21-25</b> | Celebrate a little. Your neighborhood is pretty good. |
| 3. _____            | <b>16-20</b> | Okay, but it needs work.                              |
| 4. _____            | <b>11-15</b> | It needs lots of work. You deserve better than that.  |
| 5. _____            | <b>5-10</b>  | It's a disaster for walking!                          |
| <b>Total:</b> _____ |              |   |

Now that you've identified the problems,  
go to the next page to find out how to fix them.

Now that you know the problems, you can find the answers.

# Improving your community's score

## 1. Did you have room to walk?

Sidewalks or paths started and stopped  
Sidewalks broken or cracked  
Sidewalks blocked  
No sidewalks, paths or shoulders  
Too much traffic

### What you and your child can do immediately

- pick another route for now
- tell local traffic engineering or public works department about specific problems and provide a copy of the checklist

### What you and your community can do with more time

- speak up at board meetings
- write or petition city for walkways and gather neighborhood signatures
- make media aware of problem
- work with a local transportation engineer to develop a plan for a safe walking route

## 2. Was it easy to cross streets?

Road too wide  
Traffic signals made us wait too long or did not give us enough time to cross  
Crosswalks/traffic signals needed  
View of traffic blocked by parked cars, trees, or plants  
Needed curb ramps or ramps needed repair

- pick another route for now
- share problems and checklist with local traffic engineering or public works department
- trim your trees or bushes that block the street and ask your neighbors to do the same
- leave nice notes on problem cars asking owners not to park there

- push for crosswalks/signals/ parking changes/curb ramps at city meetings
- report to traffic engineer where parked cars are safety hazards
- report illegally parked cars to the police
- request that the public works department trim trees or plants
- make media aware of problem

## 3. Did drivers behave well?

Backed without looking  
Did not yield  
Turned into walkers  
Drove too fast  
Sped up to make traffic lights or drove through red lights

- pick another route for now
- set an example: slow down and be considerate of others
- encourage your neighbors to do the same
- report unsafe driving to the police

- petition for more enforcement
- request protected turns
- ask city planners and traffic engineers for traffic calming ideas
- ask schools about getting crossing guards at key locations
- organize a neighborhood speed watch program

## 4. Could you follow safety rules?

Cross at crosswalks or where you could see and be seen  
Stop and look left, right, left before crossing  
Walk on sidewalks or shoulders facing traffic  
Cross with the light

- educate yourself and your child about safe walking
- organize parents in your neighborhood to walk children to school

- encourage schools to teach walking safely
- help schools start safe walking programs
- encourage corporate support for flex schedules so parents can walk children to school

## 5. Was your walk pleasant?

Needs grass, flowers, trees  
Scary dogs  
Scary people  
Not well lit  
Dirty, litter  
Lots of traffic

- point out areas to avoid to your child; agree on safe routes
- ask neighbors to keep dogs leashed or fenced
- report scary dogs to the animal control department
- report scary people to the police
- report lighting needs to the police or appropriate public works department
- take a walk with a trash bag
- plant trees, flowers in your yard
- select alternative route with less traffic

- request increased police enforcement
- start a crime watch program in your neighborhood
- organize a community clean-up day
- sponsor a neighborhood beautification or tree-planting day
- begin an adopt-a-street program
- initiate support to provide routes with less traffic to schools in your community (reduced traffic during am and pm school commute times)

## A Quick Health Check

Could not go as far or as fast as we wanted  
Were tired, short of breath or had sore feet or muscles  
Was the sun really hot?  
Was it hot and hazy?

- start with short walks and work up to 30 minutes of walking most days
- invite a friend or child along
- walk along shaded routes where possible
- use sunscreen of SPF 15 or higher, wear a hat and sunglasses
- try not to walk during the hottest time of day

- get media to do a story about the health benefits of walking
- call parks and recreation department about community walks
- encourage corporate support for employee walking programs
- plant shade trees along routes
- have a sun safety seminar for kids
- have kids learn about unhealthy ozone days and the Air Quality Index (AQI)

Need some guidance? These resources might help...

# Great Resources

## WALKING INFORMATION

### **Pedestrian and Bicycle Information Center (PBIC)**

UNC Highway Safety Research Center  
Chapel Hill, NC  
[www.pedbikeinfo.org](http://www.pedbikeinfo.org)  
[www.walkinginfo.org](http://www.walkinginfo.org)

### **National Center for Safe Routes to School**

Chapel Hill, NC  
[www.saferoutesinfo.org](http://www.saferoutesinfo.org)

### **For More Information about Who Can Help Address Community Problems**

[www.walkinginfo.org/problems/help.cfm](http://www.walkinginfo.org/problems/help.cfm)

### **State Bicycle & Pedestrian Coordinators**

<http://www.walkinginfo.org/assistance/contacts.cfm>

## FEDERAL POLICY, GUIDANCE AND FUNDING SOURCES FOR WALKING FACILITIES

### **Federal Highway Administration**

Bicycle and Pedestrian Program  
Office of Natural and Human Environment  
Washington, DC  
[www.fhwa.dot.gov/environment/bikeped/index.htm](http://www.fhwa.dot.gov/environment/bikeped/index.htm)

## PEDESTRIAN SAFETY

### **Federal Highway Administration**

Pedestrian and Bicycle Safety Team  
Office Of Safety  
Washington, DC  
[http://safety.fhwa.dot.gov/ped\\_bike/](http://safety.fhwa.dot.gov/ped_bike/)

### **National Highway Traffic Safety Administration**

Traffic Safety Programs  
Washington, DC  
[www.nhtsa.gov/Pedestrians](http://www.nhtsa.gov/Pedestrians)

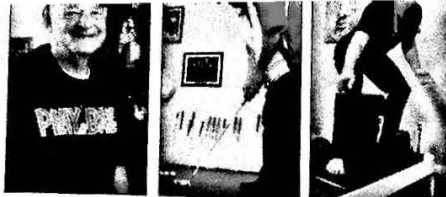
## SIDEWALK ACCESSIBILITY INFORMATION

### **US Access Board**

Washington, DC  
Phone: (800) 872-2253;  
(800) 993-2822 (TTY)  
[www.access-board.gov](http://www.access-board.gov)







# Around the Town



Shelley Russi relaxes on a piece of equipment.

## Alameda Becomes a Fit City

*A new fitness park means Islanders can exercise in style outdoors.*

**O**n a warm, sunny day in Lincoln Park, four adults are working out on the gleamingly brand-new exercise equipment. A middle-aged man pulls himself up on the pull-up bars, and a young mother does bench presses. Meanwhile, an older woman uses a rotating stool to help loosen her hips, and an older man spends a good 15 minutes on a manual Nordic track.

BY SUSAN E. DAVIS PHOTOGRAPHY CHRIS DUFFEY

With the gorgeous oak trees, the smell of freshly cut grass, and the sounds of young children laughing on the nearby play structure, it's an idyllic scene. That's exactly what Shelley Russi, 43, who is a board member for Alameda's Friends of the Parks Foundation and an NCAA women's basketball referee, envisioned when she first proposed the project two years ago. →



## Around the Town

"Cities all across the country and the world have these kinds of outdoor fitness parks or green exercise facilities for their residents," she says. "I wanted to help Alamedans get outside more and get more exercise. I'd like to see people of all ages here—already we have everyone from super-fit men who run marathons to 95-year-old grandmothers. But I'm also hoping parents will work out while their kids are on the play structure or in games on the playing fields. And if kids see their parents working out, maybe they'll believe, when they are 25, that exercise is something everyone does." (Children need to be over 12 years old to use the equipment.)

Each piece of equipment has a sticker that explains how to use it, along with a diagram and a QR code that people with smartphones can use to get more detailed directions. Russi, who lives in Alameda with her husband and two daughters, hopes that someday corporations or nonprofits will sponsor pieces of equipment and use the code to publicize more information about their organization or cause.

Russi's dream of making Alameda a Fit City has the full backing of the foundation. "When Shelley first told us about her idea, we realized it was a natural for us," says Bill Delaney, who is president of the foundation board and also a member of the Alameda Recreation and Park Commission. "The city of Alameda is increasingly working on helping its residents get healthier; exercise is a key part of that. And Shelley herself is a poster child for health and wellness. She has been the driving force behind this and helped us all understand the value of a Fit City initiative."

The Lincoln Park exercise equipment—which includes a balance beam, a push-up and dip station, a mock elliptical machine, and machines that work the abdominals, lower back, arms, and quadriceps—was installed in January. A smaller exercise area was installed at Washington Park two years ago. But eventually, Russi and others involved with the foundation hope, the city will boast a network of 10 to 15 fitness parks across the city, each with a different flavor and different kinds of equipment. Each park installation costs between \$20,000 and \$30,000, Russi estimates, for a total bill of about \$400,000. The next fitness area could be an expansion of the Washington Park facility or a new area at either a Bay Farm park or the Jean Sweeney Open Space Park.

The Fit City Initiative is funded entirely by donations, including from Wind River Systems, civic organizations, and individuals. Want to contribute to the effort? You can donate via PayPal on the foundation's website, [www.alamedaparks.org](http://www.alamedaparks.org). Or join the foundation's inaugural Play for the Parks golf tournament on Sept. 25, the proceeds of which will help fund the outdoor exercise project, as well as other foundation initiatives.



## Tennis, Anyone?

**A former champ challenges top players to popularize the game and raise money for charity.**

**A**ny middle-aged men out there up for a tennis challenge? Former Alameda resident, ex-cop, and tennis world-record holder Rob Peterson is and has embarked upon his goal to be the oldest man—at age 54—to beat a Top 100 men's player from the Association of Tennis Professionals tour.

Now 51, he's given himself three years to reach his goal. "I'm pushing the limits of age and will," says the longtime tennis club teaching professional and former United States Tennis Association tennis volunteer of the year.

Peterson's now in phase one of his quest. "It's about getting in shape, training three to four days a week, watching the diet, running, stretching, and losing 15 pounds," he says.

But he's realistic that it won't be easy to get healthy and play against junior varsity Division I players who are 30 years younger—the elite athletes he will need to test himself against to reach his goal. So he's working on his specialty shots such as dinks, drops, and angles. "I can't overpower them anymore," he says.

He hopes the culmination of his training will fall on his 54th birthday, Aug. 18, 2015, in Las Vegas, with him beating a Top-100 professional player in a high-publicity challenge match that will offer six-figure prize money.

Known as the marathon man in the tennis world, Peterson has set seven world records in tennis at staged events that have all been undertaken to promote tennis and raise money for charities. So, it's not beyond his reach to attain his goal and set another world record.

In 1998, Peterson set the Guinness World Record for the most consecutive tennis serves

at 8,017 in a time of 10 hours and seven minutes in Port Aransas, Texas. In 2001, he and tennis pro Ray Miller set the Guinness World Record for longest rally at 9 hours and six minutes and hit 17,062 shots at a USTA tennis festival event in Alameda. One of his biggest moments came in 2000 at Serve Up a Cure, a charity event in New York City's Grand Central Station. The USTA set up a tennis court in the middle of the iconic main concourse, where he hit 1,291 serves in just over an hour.

Peterson and his wife, Rebecca, moved to Alameda in 1996. He won the men's singles Alameda City Championships that year. Although they only lived here a year, the couple still love with Alameda, and Peterson spent time at the Washington Park tennis courts.

Peterson currently lives in Petaluma, Calif., where he has a tennis training center, and he trains for three to four days a week.

"I've been a part in the San Francisco Bay Area. Peterson still owns a tennis shop in Sausalito. "I've tried other sports, but they just didn't do it for me. It's one of these things that I've really enjoyed, it's kept me fit, and I have enjoyed the challenge of competing against others," he says.

As always, his tennis challenge match in Vegas will also serve to support a charity, but this time it will be Peterson's own Operation Lifeshield, which raises money to build bomb shelters to defend Israel against attack.

—Keith Gleason

For more information on Rob Peterson, go to: [www.txtennispro.com](http://www.txtennispro.com).